















**Brand  
You Can  
Trust  
For Your  
Bearing  
Solutions**

**ASB<sup>®</sup>**

**ASB Ball and Roller Bearings**

## Technical Data

<b>Deep Groove Ball Bearing</b>		1 - 20
<b>Miniature Ball Bearings</b>		21 - 24
<b>Angular Contact Ball Bearings</b>		25 - 40
<b>Self-aligning Ball Bearings</b>		41 - 44
<b>Cylindrical Roller Bearings</b>		45 - 60
<b>Needle Roller Bearings</b>		61 - 92
<b>Cam Followers</b>		93 - 94
<b>Rod ends Bearings</b>		95 - 96
<b>Spherical Plain Bearings</b>		97 - 98
<b>Tapered Roller Bearings</b>		99 - 126
<b>Spherical Roller Bearings</b>		127 - 136
<b>Spherical Roller Trust Bearings</b>		137 - 140
<b>Thrust Ball Bearings</b>		141 - 150
<b>Bearing Units</b>		151 - 174
<b>Plummer Block</b>		175 - 178

**Deep Groove Ball Bearings**

- **Open Type With Shields,seals And Flange Type**  
Series 67 , 68 , 69 , 60 , 62 , 63 , 64 , 68 , 69 , 160 ..... 1
- **Inch size**  
RMS , RLS , R

**Miniatur Ball Bearings**

- **Open type with shields,seals and Flange type**  
Series 67 , 68 , 69 , 60 , 62 , MR ..... 21

**Angular Contact Ball Bearings**

- **Single and duplex arrangement**  
Series 79 , 70 , 72 , 72B , 73B ..... 25
- **Double row type Angular Contact Ball Bearings**
- **With filling slots**  
Series 32 , 33 ..... 35
- **Without filling slots**  
Series 52 , 53 ..... 37
- **Four Point Contact Ball Bearings**  
Series QJ ..... 39

**Self-aligning Ball Bearings**

- Series 12(K) , 22(K) ,13(K) ,23(K) ..... 41

**Cylindrical Roller Bearings**

- **Single row type**  
Series NU, NJ , NUP , N , NF ,NP ..... 45
- **Double row type**  
Series NNU49(K) , NN49(K) , NN30(K) ..... 59

**Needle Roller Bearings**

- **Caged Assambles type**  
Series KT, HK, HMK, HKS, BA, NK, NKS, NA, BR, IR ..... 61
- **Cam Follower, Rod Ends, Spherical Plain Bearings**  
CF, CR, POS, PHS, GE, SBB ..... 93

**Tapered Roller Bearings**

- **Metric size**  
Series 329, 320X, 330 , 331 , 302 , 322 , 332 , 303 , 303D , 323 , 323 ..... 99
- **Inch size**  
Series Inch ..... 114

**Spherical Roller Bearings**

- Series 239(K) , 230(K) , 240(K30) , 231(K) , 241(K30) , 222(K) , 232(K) , 213(K) , 223(K) ..... 127

**Thrust Roller Bearings**

- **Spherical Roller Thrust Bearings**  
Series 292 , 293 , 294 ..... 137
- **Single Row Thrust Ball Bearings**  
Series 511 , 512 , 513 , 514 , 29 , 39 , 9 ..... 141
- **Inch size**  
Series 0 ..... 149



**Ball Bearing Units**

- **Insert Bearing Units**  
UC , UCX ..... 151
- **Block Bearing Units**  
UCP , UCPIX , UCPH , UKP , UCF , UCFL , UCT , UP , UFL ..... 156

**Bearing Housings**

















- **Split Plummer Block Housings**  
Series SN ..... 176



















# Classification and Types of Rolling Contact Bearings

Bearing Type Features	Deep Groove Ball Bearings	Angular Contact Ball Bearings	Double Row Angular Contact Ball Bearings	Duplex Mounting Angular Contact Ball Bearings	Self - Aligning Ball Bearing	Cylindrical Roller Bearings
Load Carrying Capacity						
High Speed Rotation	****	****	**	***	**	***
Accuracy	***	***	*	***	*	***
Low Noise • Low Torque	***	***	*	**	*	**
Allowable Aligning Of Inner Ring • Outer Ring	**	*	*	*	***	*
Rigidity	*	*	*	**	*	**
Aligning Action					O	
Separable Inner Ring • Outer Ring						O
Applicable to "Fix Side"	O		O	O		
Applicable to "Free Side" Only						O
Inner Ring With Tapered Bore	O				O	O

## Remarks

- The Number of \* indicate bearing type characteristics. The more \* the better characteristic. X mean "not applicable".
- ↑ and ← → shows Radial and axial load, its also means single and double directions
- O mean "applicable" VDSA
- This table is for reference only. Specific application should be selected or the bearings.

Double Row Cylindrical Roller Bearings	Needle Roller Bearings	Tapered Roller Bearings	Double-row, 4-row Tapered Roller Bearings	Spherical Roller Bearings	Thrust Ball Bearings	Cylindrical Roller Thrust Bearings	Spherical Roller Thrust Bearings
							
							
***	***	***	**	**	*	*	*
***	*	***	*	*	*	*	*
**	*	*	*	*	**	*	*
*	*	*	*	***	X	X	***
***	**	**	****	***	*	***	***
				O			O
O	O	O	O		O	O	O
			O	O			
O	O						
O				O			

Bearing series		Appearance	Directio of motion	Load direction and capacity	Allowable rotational speed	Friction	Sectional Height
Cam Followers	Caged Type				●	●	▲
Needle Roller Cages	For General Usage				★	★	★
Shell Type Needle Roller Bearings	Caged Type				●	●	★
Machined Type Needle Roller Bearings	Caged Type				●	★	●
Spherical Bushings	Steel on Steel Type				▲	▲	▲
Pillo Balls	Insert Type, Lubrication ype				▲	▲	▲

★ Best

● Excellent

▲ Normal

Symbol	Example of Designation	Meaning
RS	6205 RS	Seal on one side adhering to a flat surface of the inner ring
2RS	6307 2RS	Seal on both sides adhering to a flat surface of the inner ring
Z	6206 Z	Metal shield on one side
ZZ	6208 ZZ	Metal shields on both sides adhering to a flat surface of the inner ring
P6	6205 P6	Higher tolerance class than standard
P5	6307 P5	Higher tolerance class than P6
C2	6304 C2	Radial clearance less than normal
C3	6305 ZZ C3	Radial clearance greater than normal
C4	6307 2RS C4	Radial clearance greater than C3
C5	6206 ZZ C5	Radial clearance greater than C4
C6	6305 C6	Reduced vibration level

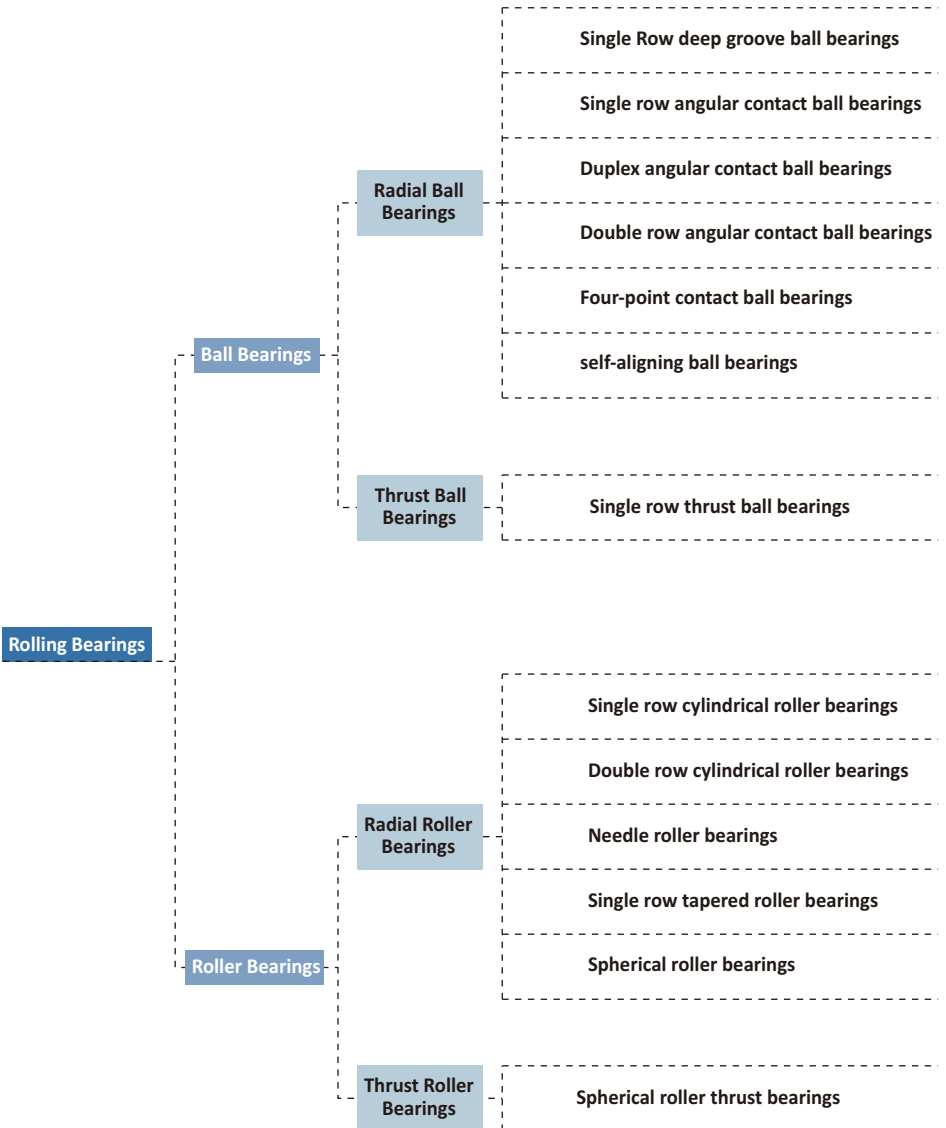

# Bearings Series Symbol

Bearing series	Type	Dimension series		Bearing type
		Width series	Diameter series	
67	6	(1)	7	Single Row Deep Groove Ball Bearings
68		(1)	8	
69		(1)	9	
60		(1)	0	
62		(0)	2	
63		(0)	3	
78	7	(1)	8	Single Row Angular Contact Ball Bearings
79		(1)	9	
70		(1)	0	
72		(0)	2	
73		(0)	3	
12		1	(0)	
13	1	(0)	3	
22	2	(2)	2	
23	2	(2)	3	
NU10	NU	1	0	Cylindrical Roller Bearings
NU2		(0)	2	
NU22		2	2	
NU3		(0)	3	
NU23		2	3	
NU4		(0)	4	
N10	N	1	0	
N2		(0)	2	
N3		(0)	3	
N4		(0)	4	
NF2	NF	(0)	2	
NF3		(0)	3	
NA48	NA	4	8	Needle Roller bearings
NA49		4	9	
NA59		5	9	
329	3	2	9	Tapered Roller Bearings
320		2	0	
302		0	2	
322		2	2	
303		0	3	
303D		0	3	
313		1	3	
323		2	3	
239	2	3	9	Spherical Roller Bearings
230		3	0	
240		4	0	
231		3	1	
241		4	1	
222		2	2	
232		3	2	
213		0	3	
223		2	3	
511		5	1	
512	2			
513	3			
514	4			
522	5	2	2	Double-Thrust Ball Bearings
523			3	
524			4	
811	8	1	1	Cylindrical Roller Thrust Bearings
812		1	2	
893		9	3	
292	2	9	2	Spherical Roller Thrust Bearings
293			3	
294			4	



Code	Explanation	
Internal Modificaation	U	Internationally Interchangeable Tapered Roller Bearings
	R	Non-Internationally Interchangeable Tapered Roller Bearings
	ST	Low Torque Tapered Roller Bearings
	HT	High Axial Load Use Cylindrical Roller Bearings
Cage	M	Machined Brass Cage
	E	Machined Steel Cage
	G1	Machined Brass Cage For Cylindrical Roller Bearings, Rivetless
	G2	Pin-type Steel Cage For Tapered Roller Bearings
	J	Pressed Steel Cage
	T	Phenolic Cage
TV	Plastic Cage, Nylon Or Teflon	
Seal Shield	2RS	Synthetic Rubber Seal (Contact Seal Type)
	ZZ	Shield
Snap Ring	K	Tapered Inner Ring Bore, Taper
	N	Snap Ring Groove On Outer Ring, But Without Snap Ring
	NR	Snap Ring On Outer Ring
	D	Bearings With Oil Holes
Duplex Arrangement	DB	Back - To - Back Arrangement
	DF	Face-to-face Arrangement
	DT	Tandem Arrangement
	D2	Two Identical Paired Bearings
Internal Clearance	C2	Radial Internal Clearance Less Than Normal
	C3	Radial Internal Clearance Greater Than Normal
	C4	Radial Internal Clearance Greater Than C3
	CM	Radial Internal Clearance For Electric Motor Bearings
	NA	Non-Interchangeable Clearance (Shown After Clearance Code)
Tolerance Standard	P6	JIS Standard Class 6
	P5	JIS Standard Class 5
	P4	JIS Standard Class 4
	P2	JIS Standard Class 2
	2	Class 2 For Inch Series Tapered Roller Bearings
	3	Class 3 For Inch Series Tapered Roller Bearings
	0	Class 0 For Inch Series Tapered Roller Bearings
	0	Class 00 For Inch Series Tapered Roller Bearings



**ASB<sup>®</sup>**

**Deep  
Groove  
Ball  
Bearings**

## Deep Groove Ball Bearings

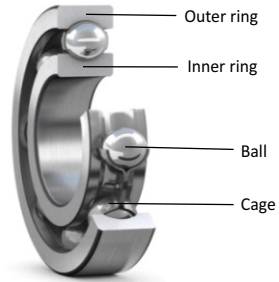
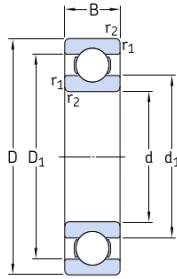

Bearing No.	Boundary dimensions(mm)			r(mm)	Cr(N)	Cor(N)	Limiting Speed (min <sup>-1</sup> )		Mass (Kg)
	d	D	B				Grease	Oil	
6000	10	26	8	0.3	4 090	1 770	30 000	36 000	0.022
6001	12	28	8	0.3	4 590	2 200	28 000	32 000	0.022
6002	15	32	9	0.3	5 040	2 500	24 000	28 000	0.034
6003	17	35	10	0.3	5 400	2 900	22 000	26 000	0.040
6004	20	42	12	0.6	8 460	4 500	18 000	21 000	0.071
6005	25	47	12	0.6	9 100	5 300	15 000	18 000	0.082
6006	30	55	13	1	11 900	7 500	13 000	15 000	0.116
6007	35	62	14	1	14 400	9 300	12 000	14 000	0.154
6008	40	68	15	1	15 200	10 400	10 000	12 000	0.194
6009	45	75	16	1	18 800	13 600	9 200	11 000	0.236
6010	50	80	16	1	19 600	14 900	8 500	10 000	0.260
6011	55	90	18	1.1	25 500	19 000	7 700	9 000	0.390
6012	60	95	18	1.1	26 450	20 800	7 100	8 500	0.420
6013	65	100	18	1.1	27 450	22 600	6 700	8 000	0.440
6014	70	110	20	1.1	34 200	28 000	6 100	7 100	0.600
6015	75	115	20	1.1	35 550	30 000	5 700	6 700	0.640
6016	80	125	22	1.1	42 750	35 500	5 300	6 300	0.850
6017	85	130	22	1.1	44 550	38 700	5 000	6 000	0.904
6018	90	140	24	1.5	52 200	44 600	4 800	5 600	1.154



Open



ZZ



2RS



ZZNR

Bearing No.	Boundary dimensions(mm)			r(mm)	Cr(N)	Cor(N)	Limiting Speed (min-1)		Mass (Kg)
	d	D	B				Grease	Oil	
6019	95	145	24	1.5	54 450	48 600	4 500	5 300	1.200
6020	100	150	24	1.5	54 000	48 600	4 300	5 300	1.252
6021	105	160	26	2	65 250	59 000	4 000	4 800	1.600
6022	110	170	28	2	76 000	65 700	3 800	4 500	1.952
6024	120	180	28	2	79 200	71 500	3 600	4 300	2.100
6026	130	200	33	2	95 400	90 900	3 200	3 800	3.176
6028	140	210	33	2	99 000	98 100	3 000	3 600	3.590
6030	150	225	35	2.1	113 400	113 400	2 600	3 200	4.166
6032	160	240	38	2.1	123 300	121 500	2 600	3 000	5.220
6034	170	260	42	2.1	144 900	144 000	2 400	2 800	7.000
6036	180	280	46	2.1	156 600	162 000	2 300	2 700	8.930
6038	190	290	46	2.1	169 200	180 000	2 100	2 500	9.340
6040	200	310	51	2.1	181 800	199 800	2 000	2 400	11.740
6044	220	340	56	3	192 600	223 200	1 800	2 200	16.300
6048	240	360	56	3	199 800	241 200	1 700	2 000	19.500
6052	260	400	65	4	226 800	288 000	1 500	1 800	29.600
6056	280	420	65	4	239 400	315 000	1 400	1 600	30.900
6060	300	460	74	4	319 500	441 000	1 300	1 500	44.000
6064	320	480	74	4	306 000	423 000	1 200	1 400	46.700

## Deep Groove Ball Bearings

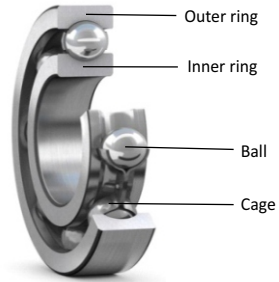
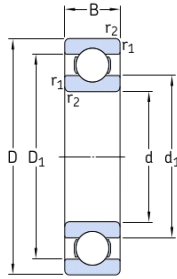

Bearing No.	Boundary dimensions(mm)			r(mm)	Cr(N)	Cor(N)	Limiting Speed (min <sup>-1</sup> )		Mass (Kg)
	d	D	B				Grease	Oil	
6200	10	30	9	0.6	4 590	2 150	25 000	30 000	0.034
6201	12	32	10	0.6	6 150	2 800	22 000	28 000	0.038
6202	15	35	11	0.6	6 900	3 400	20 000	24 000	0.046
6203	17	40	12	0.6	8 590	4 300	18 000	21 000	0.067
6204	20	47	14	1	11 500	5 900	16 000	18 000	0.102
6205	25	52	15	1	12 600	7 100	13 000	16 000	0.120
6206	30	62	16	1	17 550	10 200	11 000	13 000	0.194
6207	35	72	17	1.1	23 150	13 800	9 800	11 000	0.274
6208	40	80	18	1.1	26 190	16 200	8 700	10 000	0.352
6209	45	85	19	1.1	29 250	18 500	7 800	9 300	0.408
6210	50	90	20	1.1	31 500	20 900	7 100	8 600	0.458
6211	55	100	21	1.5	39 150	26 400	6 400	7 700	0.610
6212	60	110	22	1.5	47 250	32 400	6 000	7 100	0.780
6213	65	120	23	1.5	51 300	36 000	5 500	6 500	0.986
6214	70	125	24	1.5	55 800	39 600	5 100	6 300	1.052
6215	75	130	25	1.5	59 400	44 600	4 800	5 600	1.170
6216	80	140	26	2	65 250	47 700	4 500	5 300	1.420
6217	85	150	28	2	75 600	55 800	4 300	5 000	1.745



Open



ZZ



2RS



ZZNR

Bearing No.	Boundary dimensions(mm)			r(mm)	Cr(N)	Cor(N)	Limiting Speed (min-1)		Mass (Kg)
	d	D	B				Grease	Oil	
6218	90	160	30	2	86 400	64 400	4 000	4 800	2.094
6219	95	170	32	2.1	98 100	73 400	3 800	4 500	2.556
6220	100	180	34	2.1	109 800	83 700	3 600	4 300	3.100
6221	105	190	36	2.1	119 700	93 600	3 400	4 000	3.620
6222	110	200	38	2.1	129 600	105 300	3 200	3 800	4.362
6224	120	215	40	2.1	130 500	106 200	2 900	3 400	5.120
6226	130	230	40	3	150 300	131 400	2 700	3 200	5.800
6228	140	250	42	3	149 400	135 000	2 500	2 900	7.460
6230	150	270	45	3	158 400	151 200	2 200	2 600	9.640
6232	160	290	48	3	166 500	167 400	2 100	2 500	12.300
6234	170	310	52	4	190 800	201 600	2 000	2 400	15.500
6236	180	320	52	4	204 300	217 800	1 900	2 200	17.040
6238	190	340	55	4	229 500	253 800	1 800	2 100	21.800
6240	200	360	58	4	241 200	279 000	1 700	2 000	28.000
6244	220	400	65	4	279 000	337 500	1 500	1 800	35.400
6248	240	440	72	4	306 000	387 000	1 200	1 500	48.800
6252	260	480	80	5	360 000	486 000	1 100	1 400	65.400
6256	280	500	80	5	360 000	495 000	1 000	1 300	70.000
6260	300	540	85	5	418 500	603 000	950	1 200	86.000

# Deep Groove Ball Bearings

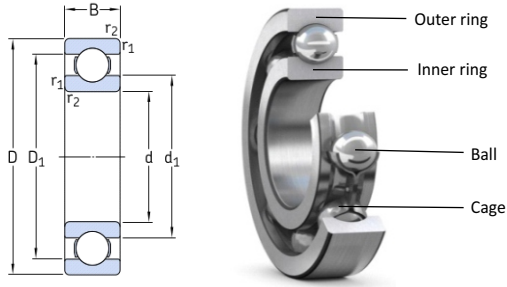

Bearing No.	Boundary dimensions(mm)			r(mm)	Cr(N)	Cor(N)	Limiting Speed (min-1)		Mass (Kg)
	d	D	B				Grease	Oil	
6300	10	35	11	0.6	7 300	3 100	23 000	27 000	0.056
6301	12	37	12	1	8 800	3 850	20 000	24 000	0.064
6302	15	42	13	1	10 200	4 900	17 000	21 000	0.082
6303	17	47	14	1	12 250	5 900	16 000	19 000	0.112
6304	20	52	15	1.1	14 300	7 100	14 000	17 000	0.147
6305	25	62	17	1.1	21 300	10 900	12 000	14 000	0.218
6306	30	72	19	1.1	24 000	13 500	10 000	12 000	0.334
6307	35	80	21	1.5	30 200	17 300	8 800	10 000	0.440
6308	40	90	23	1.5	36 500	21 700	7 800	9 200	0.639
6309	45	100	25	1.5	47 700	28 800	7 000	8 200	0.836
6310	50	110	27	2	55 800	34 200	6 400	7 500	1.072
6311	55	120	29	2	64 350	40 000	5 800	6 800	1.348
6312	60	130	31	2.1	73 800	46 800	5 400	6 300	1.692
6313	65	140	33	2.1	83 500	53 550	4 900	6 000	2.058
6314	70	150	35	2.1	93 600	61 200	4 600	5 400	2.440
6315	75	160	37	2.1	101 700	69 300	4 300	5 000	2.976
6316	80	170	39	2.1	110 700	77 900	4 000	4 800	3.500
6317	85	180	41	3	119 700	86 900	3 800	4 500	4.030
6318	90	190	43	3	128 700	96 300	3 600	4 300	4.760
6319	95	200	45	3	137 700	106 200	3 300	3 900	5.540
6320	100	215	47	3	155 700	126 900	3 200	3 700	6.840
6321	105	225	49	3	165 600	137 700	3 000	3 600	8.250
6322	110	240	50	3	184 500	161 000	2 900	3 400	9.860
6324	120	260	55	3	186 300	166 500	2 600	3 100	12.060
6326	130	280	58	4	206 100	192 600	2 400	2 800	14.700
6328	140	300	62	4	227 700	221 400	2 200	2 600	18.360
6330	150	320	65	4	246 600	255 600	2 000	2 400	26.000
6332	160	340	68	4	250 200	258 300	1 900	2 300	29.000
6334	170	360	72	4	292 500	319 000	1 800	2 100	34.500
6336	180	380	75	4	292 500	324 000	1 700	2 000	43.100
6338	190	400	78	5	319 500	373 000	1 600	1 900	47.000
6340	200	420	80	5	342 000	400 500	1 500	1 800	58.000





Open



ZZ



2RS



ZZNR

Bearing No.	Boundary dimensions(mm)			r(mm)	Cr(N)	Cor(N)	Limiting Speed (min-1)		Mass (Kg)
	d	D	B				Grease	Oil	
6403	17	62	17	1.1	20 400	9 800	14 000	16 000	0.272
6404	20	72	19	1.1	25 700	12 400	12 000	14 000	0.402
6405	25	80	21	1.5	31 000	15 800	10 000	12 000	0.530
6406	30	90	23	1.5	38 700	21 200	8 800	10 000	0.692
6407	35	100	25	1.5	49 500	27 900	7 800	9 100	0.922
6408	40	110	27	2	56 700	32 500	7 000	8 100	1.176
6409	45	120	29	2	69 500	40 600	6 300	7 400	1.464
6410	50	130	31	2.1	74 700	44 500	5 700	6 700	1.824
6411	55	140	33	2.1	79 200	49 000	5 200	6 100	2.188
6412	60	150	35	2.1	90 000	58 000	4 800	5 700	2.658
6413	65	160	37	2.1	99 900	64 900	4 400	5 100	3.268
6414	70	180	42	3	116 000	79 200	4 100	4 800	4.830
6415	75	190	45	3	121 500	88 200	3 800	4 500	5.680
6416	80	200	48	3	147 600	112 000	3 600	4 100	6.660
6417	85	210	52	4	153 000	117 000	3 400	4 000	7.950
6418	90	225	54	4	165 600	134 000	3 200	3 800	11.400
6419	95	240	55	4	167 400	137 700	3 000	3 500	13.400
6420	100	250	58	4	184 500	156 600	2 900	3 400	13.210
6700	10	15	4	0.1	900	500	36 000	42 000	0.002
6701	12	18	4	0.2	1 000	600	32 000	38 000	0.003
6702	15	21	4	0.2	1 050	700	29 000	34 000	0.003
6703	17	23	4	0.2	1 080	800	26 000	31 000	0.039
6704	20	27	4	0.2	1 580	1 200	23 000	28 000	0.055
6705	25	32	4	0.2	1 750	1 400	19 000	23 000	0.085
6706	30	37	4	0.2	1 850	1 600	17 000	20 000	0.100

## Deep Groove Ball Bearings

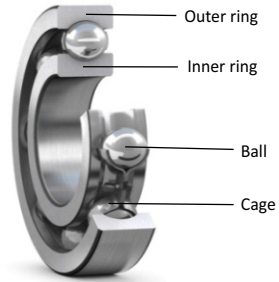
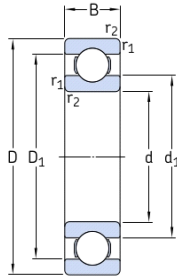

Bearing No.	Boundary dimensions(mm)			r(mm)	Cr(N)	Cor(N)	Limiting Speed (min <sup>-1</sup> )		Mass (Kg)
	d	D	B				Grease	Oil	
6800	10	19	5	0.3	1 900	900	37 000	44 000	0.004
6801	12	21	5	0.3	1 750	950	32 000	39 000	0.006
6802	15	24	5	0.3	1 900	1 150	28 000	34 000	0.008
6803	17	26	5	0.3	2 350	1 400	26 000	30 000	0.004
6804	20	32	7	0.3	3 600	2 400	22 000	26 000	0.018
6805	25	37	7	0.3	3 870	2 600	18 000	22 000	0.022
6806	30	42	7	0.3	4 850	3 400	15 000	18 000	0.030
6807	35	47	7	0.3	4 300	3 500	14 000	16 000	0.028
6808	40	52	7	0.3	5 350	4 400	12 000	14 000	0.030
6809	45	58	7	0.3	4 850	4 400	11 000	13 000	0.038
6810	50	65	7	0.3	5 760	5 300	10 000	12 000	0.046
6811	55	72	9	0.3	7 950	7 300	8 700	10 000	0.076
6812	60	78	10	0.3	10 400	9 500	8 000	9 500	0.110
6813	65	85	10	0.6	10 800	10 400	7 500	8 700	0.146
6814	70	90	10	0.6	10 900	10 700	7 000	8 100	0.156
6815	75	95	10	0.6	11 250	11 500	6 500	7 600	0.168
6816	80	100	10	0.6	11 450	12 000	6 000	7 100	0.176
6817	85	110	13	1	16 850	17 100	5 700	6 700	0.290
6818	90	115	13	1	17 100	17 800	5 400	6 300	0.320



Open



ZZ



2RS



ZZNR

Bearing No.	Boundary dimensions(mm)			r(mm)	Cr(N)	Cor(N)	Limiting Speed (min-1)		Mass (Kg)
	d	D	B				Grease	Oil	
6819	95	120	13	1	17 400	18 500	5 000	6 000	0.334
6820	100	125	13	1	17 650	19 000	4 800	5 600	0.350
6821	105	130	13	1	18 000	19 800	4 800	5 600	0.314
6822	110	140	16	1	24 600	26 500	4 300	5 300	0.513
6824	120	150	16	1	25 500	28 400	4 000	4 800	0.555
6826	130	165	18	1.1	33 300	36 900	3 700	4 400	0.767
6828	140	175	18	1.1	34 200	40 000	3 400	4 000	0.828
6830	150	190	20	1.1	42 800	49 000	3 200	3 800	1.140
6832	160	200	20	1.1	43 700	50 800	2 900	3 400	1.210
6834	170	215	22	1.1	54 000	63 500	2 700	3 200	1.600
6836	180	225	22	1.1	54 500	65 700	2 600	3 000	2.000
6838	190	240	24	1.5	65 700	79 200	2 400	2 900	2.600
6840	200	250	24	1.5	66 600	81 900	2 300	2 700	2.700
6844	220	270	24	1.5	68 850	88 200	2 100	2 400	3.140
6848	240	300	28	2	88 650	114 500	1 900	2 200	4.460
6852	260	320	28	2	90 900	122 400	1 700	2 000	5.000
6856	280	350	33	2	119 700	159 000	1 600	1 900	7.100
6860	300	380	38	2.1	149 400	197 000	1 500	1 700	9.840
6864	320	400	38	2.1	152 000	198 000	1 400	1 600	10.300

## Deep Groove Ball Bearings

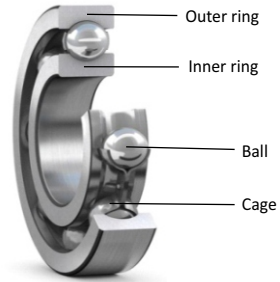
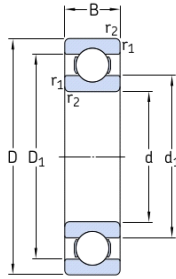

Bearing No.	Boundary dimensions(mm)			r(mm)	Cr(N)	Cor(N)	Limiting Speed (min <sup>-1</sup> )		Mass (Kg)
	d	D	B				Grease	Oil	
6900	10	22	6	0.3	2 250	1 000	33 000	38 000	0.010
6901	12	24	6	0.3	2 430	1 200	30 000	36 000	0.010
6902	15	28	7	0.3	3 870	2 000	26 000	31 000	0.016
6903	17	30	7	0.3	4 150	2 300	24 000	29 000	0.012
6904	20	37	9	0.3	5 750	3 300	19 000	23 000	0.034
6905	25	42	9	0.3	6 300	4 000	16 000	20 000	0.046
6906	30	47	9	0.3	6 500	4 500	14 000	17 000	0.052
6907	35	55	10	0.6	9 400	6 500	12 000	15 000	0.074
6908	40	62	12	0.6	12 400	9 000	11 000	13 000	0.110
6909	45	68	12	0.6	12 700	9 800	10 000	12 000	0.120
6910	50	72	12	0.6	13 000	10 500	9 500	11 000	0.128
6911	55	80	13	1	14 400	11 900	8 200	9 600	0.186
6912	60	85	13	1	13 700	12 200	7 600	9 000	0.198
6913	65	90	13	1	15 700	14 400	7 100	8 500	0.196
6914	70	100	16	1	17 000	18 500	6 500	7 700	0.304
6915	75	105	16	1	18 800	19 600	6 200	7 200	0.334
6916	80	110	16	1	24 800	22 800	5 700	6 700	0.390
6917	85	120	18	1.1	28 800	26 500	5 400	6 300	0.550
6918	90	125	18	1.1	29 700	28 400	5 100	6 000	0.598
6919	95	130	18	1.1	30 000	30 000	4 800	5 700	0.618
6920	100	140	20	1.1	38 300	32 800	4 500	5 300	0.834



Open



ZZ



2RS



ZZNR

Bearing No.	Boundary dimensions(mm)			r(mm)	Cr(N)	Cor(N)	Limiting Speed (min-1)		Mass (Kg)
	d	D	B				Grease	Oil	
6921	105	145	20	1.1	38 500	37 800	4 300	5 300	0.842
6922	110	150	20	1.1	40 000	34 600	4 300	5 000	0.878
6924	120	165	22	1.1	47 700	48 600	3 800	4 600	1.166
6926	130	180	24	1.5	58 500	60 300	3 500	4 200	1.520
6928	140	190	24	1.5	59 850	63 900	3 200	3 800	1.620
6930	150	210	28	2	77 000	78 300	3 000	3 500	2.470
6932	160	220	28	2	78 800	86 000	2 800	3 300	2.720
6934	170	230	28	2	77 400	85 500	2 600	3 100	2.840
6936	180	250	33	2	95 400	105 600	2 400	2 900	4.960
6938	190	260	33	2	97 200	110 700	2 300	2 700	5.190
6940	200	280	38	2.1	117 000	131 400	2 200	2 600	7.170
6944	220	300	38	2.1	118 800	138 600	2 000	2 300	7.450
6948	240	320	38	2.1	138 600	167 400	1 800	2 100	8.050
6952	260	360	46	2.1	183 600	228 600	1 600	1 900	13.200
6956	280	380	46	2.1	188 000	243 000	1 500	1 800	14.100
6960	300	420	56	3	242 000	333 000	1 400	1 600	21.900
6964	320	440	56	3	239 400	340 000	1 300	1 500	23.600

## Deep Groove Ball Bearings

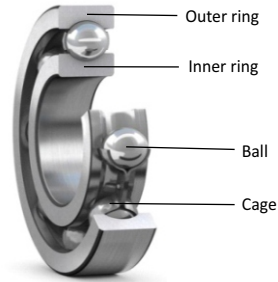
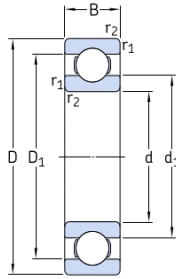

Bearing No.	Boundary dimensions(mm)			r(mm)	Cr(N)	Cor(N)	Limiting Speed (min <sup>-1</sup> )		Mass (Kg)
	d	D	B				Grease	Oil	
16001	12	28	7	0.3	4 590	2 100	26 000	30 000	0.020
16002	15	32	8	0.3	5 040	2 600	24 000	28 000	0.028
16003	17	35	8	0.3	5 400	2 900	22 000	26 000	0.036
16004	20	42	8	0.3	7 110	4 000	18 000	21 000	0.050
16005	25	47	8	0.3	6 255	4 150	15 000	18 000	0.059
16006	30	55	9	0.3	8 955	5 900	13 000	15 000	0.090
16007	35	62	9	0.3	10 530	7 400	12 000	14 000	0.114
16008	40	68	9	0.3	9 990	7 700	10 000	12 000	0.128
16009	45	75	10	0.6	11 610	9 500	9 200	11 000	0.174
16010	50	80	10	0.6	14 490	11 800	8 500	10 000	0.184
16011	55	90	11	0.6	13 680	12 200	7 700	9 000	0.266
16012	60	95	11	0.6	14 580	12 900	7 100	8 500	0.292
16013	65	100	11	0.6	18 450	16 800	6 700	8 000	0.306
16014	70	110	13	0.6	24 120	21 300	6 100	7 100	0.446
16015	75	115	13	0.6	24 840	22 800	5 700	6 700	0.464
16016	80	125	14	0.6	28 800	26 700	5 300	6 300	0.626
16017	85	130	14	0.6	28 350	26 900	5 000	6 000	0.626
16018	90	140	16	1	37 350	35 600	4 800	5 600	0.878
16019	95	145	16	1	37 500	35 600	4 600	5 300	0.920



Open



ZZ



2RS



ZZNR

Bearing No.	Boundary dimensions(mm)			r(mm)	Cr(N)	Cor(N)	Limiting Speed (min-1)		Mass (Kg)
	d	D	B				Grease	Oil	
16020	100	150	16	1	38 000	35 550	4 300	5 300	0.944
16021	105	160	18	1	38 500	45 500	4 000	4 800	1.200
16022	110	170	19	1	39 600	40 500	3 800	4 500	1.486
16024	120	180	19	1	43 200	45 000	3 600	4 300	1.624
16026	130	200	22	1.1	49 500	53 600	3 200	3 800	2.350
16028	140	210	22	1.1	50 400	55 800	3 000	3 500	2.460
16030	150	225	24	1.1	68 850	74 300	2 600	3 200	3.150
16032	160	240	25	1.5	89 100	97 200	2 400	3 000	3.800
16034	170	260	28	1.5	102 600	113 400	2 300	2 800	5.200
16036	180	280	31	2	105 300	120 600	2 200	2 700	6.700
16038	190	290	31	2	120 600	140 400	2 100	2 500	7.000
16040	200	310	34	2	127 800	144 000	2 000	2 400	9.100
16044	220	340	37	2.1	148 500	171 000	1 800	2 200	11.900
16048	240	360	37	2.1	160 200	195 300	1 700	2 100	12.400
16052	260	400	44	3	204 300	269 100	1 500	1 800	18.800
16056	280	420	44	3	208 800	283 500	1 400	1 600	22.200
16060	300	460	50	4	262 800	369 000	1 300	1 500	30.100
16064	320	480	50	4	270 000	396 000	1 200	1 400	33.300

## Deep Groove Ball Bearings

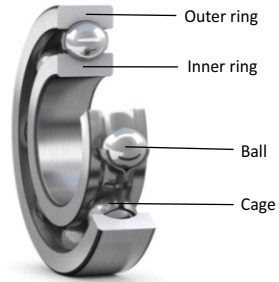
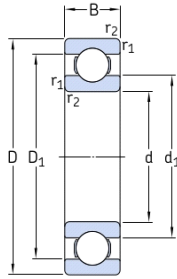

Bearing No.	Boundary dimensions(mm)			r(mm)	Cr(N)	Cor(N)	Limiting Speed (min-1)		Mass (Kg)
	d	D	B				Grease	Oil	
60/22	22	44	12	0.6	8 500	4 500	17 000	20 000	0.071
60/28	28	52	12	0.6	11 200	6 700	14 000	16 000	0.096
60/32	32	58	13	1	13 500	8 200	12 000	14 000	0.134
62/22	22	50	14	1	12 500	6 300	14 000	17 000	0.122
62/28	28	58	16	1	16 100	8 800	12 000	14 000	0.176
62/32	32	65	17	1	20 200	12 000	11 000	12 000	0.225
63/22	22	56	16	1.1	16 500	8 400	13 000	16 000	0.184
63/28	28	68	18	1.1	24 000	12 600	11 000	13 000	0.303
63/32	32	75	20	1.1	27 000	14 600	9 500	11 000	0.389





Open



ZZ



2RS



ZZNR

Bearing No.	Boundary dimensions(mm)			r(mm)	Cr(N)	Cor(N)	Limiting Speed (min-1)		Mass (Kg)
	d	D	B				Grease	Oil	
6002-10MM	10.000	32.000	9.000	0.3	5 040	2 500	24 000	28 000	0.030
6201-1/2"	12.700	32.000	10.000	0.6	5 500	2 500	22 000	26 000	0.034
6201-13MM	13.000	32.000	10.000	0.6	5 500	2 500	22 000	26 000	0.034
6202-1/2"	12.700	35.000	11.000	0.6	6 900	3 200	19 000	23 000	0.045
6202-10MM	10.000	35.000	11.000	0.6	6 900	3 300	19 000	23 000	0.045
6202-12MM	12.000	35.000	11.000	0.6	6 900	3 300	19 000	23 000	0.045
6202-16MM	16.000	35.000	11.000	0.6	6 900	3 300	19 000	23 000	0.045
6202-5/8"	15.875	35.000	11.000	0.6	6 900	3 300	19 000	23 000	0.045
6203-1/2"	12.700	40.000	12.000	0.6	8 640	4 150	18 000	21 000	0.065
6203-12MM	12.000	40.000	12.000	0.6	8 640	4 150	18 000	21 000	0.065
6203-16MM	16.000	40.000	12.000	0.6	8 640	4 150	18 000	21 000	0.065
6203-5/8"	15.875	40.000	12.000	0.6	8 640	4 150	18 000	21 000	0.065
6204-3/4"	19.050	47.000	14.000	1	11 300	6 000	16 000	18 000	0.102
6205-1"	25.400	52.000	15.000	1	12 600	7 000	13 000	15 000	0.125
6301-15MM	15.000	37.000	12.000	1	8 800	4 000	20 000	24 000	0.054
6302-10.25MM	10.250	42.000	13.000	1	10 300	4 900	17 000	21 000	0.096

## Deep Groove Ball Bearings

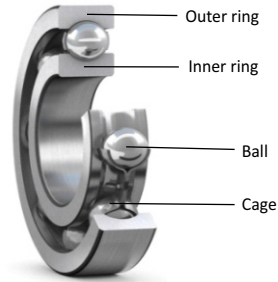
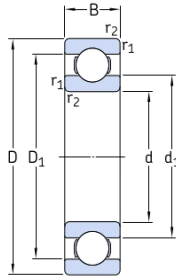

Bearing No.	Boundary dimensions(mm)			r(mm)	Cr(N)	Cor(N)	Limiting Speed (min-1)		Mass (Kg)
	d	D	B				Grease	Oil	
RMS 4	12.700	41.275	15.875	0.3	8 100	5 040	18 500	25 000	0.100
RMS 5	15.875	46.038	15.875	0.3	8 400	5 040	16 500	22 000	0.110
RMS 6	19.050	50.800	17.462	0.3	10 800	7 200	14 500	20 000	0.160
RMS 7	22.225	57.150	17.462	0.6	12 600	8 200	13 300	18 000	0.200
RMS 8	25.400	63.500	19.050	0.6	14 400	9 000	12 200	16 500	0.250
RMS 9	28.575	71.438	20.638	1	19 800	14 300	10 800	14 500	0.350
RMS 10	31.750	79.375	22.225	1	24 300	17 100	9 800	13 200	0.450
RMS 11	34.925	88.900	22.225	1	30 200	21 500	8 900	11 800	0.059
RMS 12	38.100	95.250	23.813	1.5	32 400	23 600	8 200	11 000	0.720
RMS 13	41.275	101.600	23.813	1.5	36 500	27 000	7 700	10 300	0.810
RMS 14	44.450	107.995	26.988	1.5	38 700	27 900	7 100	9 600	1.020
RMS 15	47.625	114.300	26.988	1.5	46 000	34 200	6 500	8 900	1.190
RMS 16	50.800	114.300	26.988	2	46 400	35 000	5 900	8 000	1.230
RMS 18	57.150	127.000	31.750	2	56 300	43 200	4 600	6 200	1.600
RMS 20	63.500	139.700	31.750	2	64 000	50 000	4 000	5 400	2.030
RMS 22	69.850	158.750	34.925	2	78 300	64 000	3 800	5 100	2.840



Open



ZZ



2RS



ZZNR

Bearing No.	Boundary dimensions(mm)			r(mm)	Cr(N)	Cor(N)	Limiting Speed (min-1)		Mass (Kg)
	d	D	B				Grease	Oil	
RLS 4	12.700	33.338	9.525	0.3	4 600	2 700	21 000	24 000	0.030
RLS 5	15.875	39.688	11.112	0.3	6 600	3 900	18 000	21 000	0.060
RLS 6	19.050	47.625	14.288	0.3	9 500	5 900	15 500	17 000	0.110
RLS 7	22.225	50.800	14.288	0.6	9 600	6 000	14 300	19 500	0.130
RLS 8	25.400	57.150	15.875	0.6	12 300	8 000	12 700	14 000	0.170
RLS 9	28.575	63.500	15.875	1	13 000	9 000	11 700	12 500	0.210
RLS 10	31.750	69.850	17.462	1	18 400	12 500	10 000	11 500	0.280
RLS 11	34.925	76.200	17.472	1	20 700	14 300	9 200	10 500	0.370
RLS 12	38.100	82.550	19.050	1	22 500	15 300	8 500	9 500	0.430
RLS 13	41.275	88.900	19.050	1	25 700	18 000	8 200	9 300	0.480
RLS 14	44.450	95.250	20.638	1.5	24 900	17 600	7 500	8 900	0.590
RLS 15	47.625	101.600	20.638	1.5	27 300	22 500	7 200	8 500	0.670
RLS 16	50.800	101.600	20.638	1.5	31 500	21 600	7 000	8 400	0.720
RLS 18	57.150	114.300	22.225	2	39 200	25 000	6 800	8 000	0.885
RLS 20	63.500	127.000	23.813	2	41 000	27 300	5 700	7 700	1.220
RLS 22	69.850	133.350	23.813	2	45 000	34 200	5 300	7 200	1.320
RLS 24	76.200	146.050	26.988	2.5	52 200	36 000	4 800	6 500	1.810

## Deep Groove Ball Bearings

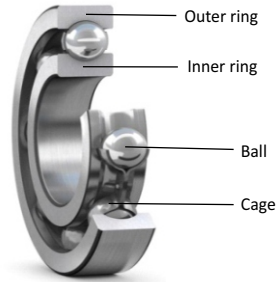
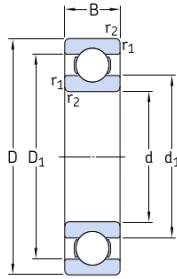

Bearing No.	Boundary dimensions(mm)			r(mm)	Cr(N)	Cor(N)	Limiting Speed (min <sup>-1</sup> )		Mass (Kg)
	d	D	B				Grease	Oil	
R 4	6.350	15.875	4.978	0.3	1 200	450	42 000	50 000	0.007
R 4A	6.350	19.050	7.142	0.3	2 000	500	38 000	45 000	0.008
R 6	9.525	22.225	5.560	0.4	2 400	1 150	31 000	37 000	0.009
R 8	12.700	28.575	6.350	0.4	4 590	2 150	27 000	32 000	0.018
R 10	15.875	34.925	7.140	0.8	7 000	3 300	20 000	24 000	0.030
R 12	19.050	41.275	7.940	0.8	7 100	4 050	17 000	21 000	0.048
R 14	22.225	47.625	9.530	0.8	8 500	4 700	15 000	19 000	0.075
R 16	25.400	50.800	9.530	0.8	12 600	7 000	13 500	16 000	0.085
R 18	28.575	53.975	9.530	0.8	11 300	6 650	12 000	14 000	0.085
R 20	31.750	57.150	9.530	0.8	13 600	8 300	10 500	12 500	0.095
R 22	34.925	63.500	11.110	0.8	14 400	9 100	9 000	11 200	0.145
R 24	38.100	66.675	11.110	0.8	13 200	9 400	7 500	9 000	0.150



Open



ZZ



2RS



ZZNR

Bearing No.	Boundary dimensions(mm)			r(mm)	Cr(N)	Cor(N)	Limiting Speed (min-1)		Mass (Kg)
	d	D	B				Grease	Oil	
62200	10	30	14	0.6	4 500	2 200	17 000	-	0.040
62201	12	32	14	0.6	6 100	2 800	15 000	-	0.053
62202	15	35	14	0.6	6 800	3 400	13 000	-	0.065
62203	17	40	16	0.6	8 600	4 350	12 000	-	0.096
62204	20	47	18	1	11 600	6 000	10 000	-	0.145
62205	25	52	18	1	12 600	7 200	8 500	-	0.172
62206	30	62	20	1	14 800	10 200	7 500	-	0.275
62207	35	72	23	1.1	23 000	13 800	6 300	-	0.410
62208	40	80	23	1.1	26 500	16 400	5 600	-	0.616
62209	45	85	23	1.1	28 500	18 700	5 000	-	0.625
62210	50	90	23	1.1	31 500	20 900	4 800	-	0.726
62211	55	100	25	1.5	39 000	26 100	4 300	-	0.750
62212	60	110	28	1.5	42 700	29 300	4 000	-	0.970

## Deep Groove Ball Bearings

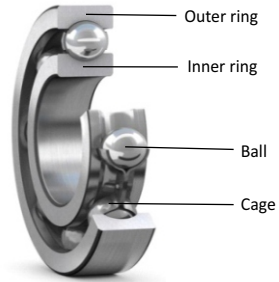
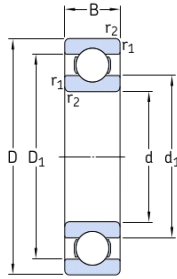

Bearing No.	Boundary dimensions(mm)			r(mm)	Cr(N)	Cor(N)	Limiting Speed (min-1)		Mass (Kg)
	d	D	B				Grease	Oil	
62300	10	35	17	0.6	7 300	3 050	15 000	-	0.060
62301	12	37	17	0.6	8 800	3 700	14 000	-	0.070
62302	15	42	17	1	10 300	4 900	12 000	-	0.110
62303	17	47	19	1	12 200	5 850	11 000	-	0.150
62304	20	52	21	1.1	14 300	7 000	9 500	-	0.200
62305	25	62	24	1.1	20 300	10 500	7 500	-	0.320
62306	30	72	27	1.1	25 200	14 400	6 300	-	0.480
62307	35	80	31	1.5	30 000	17 100	6 000	-	0.660
62308	40	90	33	1.5	36 500	21 600	5 000	-	0.880
62309	45	100	36	1.5	47 300	28 400	4 500	-	1.150
62310	50	110	40	2	55 000	34 200	4 300	-	1.550



Open



ZZ



2RS



ZZNR

Bearing No.	Boundary dimensions(mm)			r(mm)	Cr(N)	Cor(N)	Limiting Speed (min-1)		Mass (Kg)
	d	D	B				Grease	Oil	
63000	10	26	12	0.3	4 200	1 800	19 000	-	0.025
63001	12	28	12	0.3	4 500	2 200	17 000	-	0.028
63002	15	32	13	0.3	5 000	2 600	14 000	-	0.039
63003	17	35	14	0.3	5 400	3 000	13 000	-	0.052
63004	20	42	16	0.6	8 400	4 500	11 000	-	0.085
63005	25	47	16	0.6	10 000	5 900	9 500	-	0.100
63006	30	55	19	1	12 000	7 500	8 000	-	0.160
63007	35	62	20	1	14 300	9 200	7 000	-	0.210
63008	40	68	21	1	15 200	10 500	6 300	-	0.260
63009	45	75	23	1	18 800	13 200	5 600	-	0.340
63010	50	80	23	1	19 500	14 400	5 000	-	0.370





**ASB<sup>®</sup>** | 



**Miniature  
Ball  
Bearings** | 

## Miniature Ball Bearings

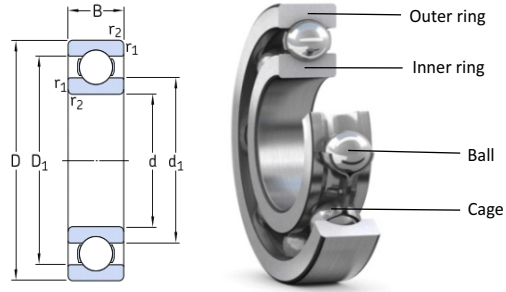

Bearing No.	Boundary dimensions(mm)			r(mm)	Cr(N)	Cor(N)	Limiting Speed (min <sup>-1</sup> )		Mass (Kg)
	d	D	B				Grease	Oil	
602	2	7	2.8	0.15	340	115	62 000	73 000	0.054
603	3	9	3	0.15	570	200	50 000	59 000	0.092
604	4	12	4	0.2	870	320	43 000	51 000	0.210
605	5	14	5	0.2	1 200	450	39 000	46 000	0.350
606	6	17	6	0.3	1 970	800	35 000	42 000	0.600
607	7	19	6	0.3	2 000	820	34 000	40 000	0.800
608	8	22	7	0.3	3 000	1 260	32 000	37 000	0.120
609	9	24	7	0.3	3 060	1 300	31 000	36 000	0.140
623	3	10	4	0.15	580	200	50 000	58 000	0.016
624	4	13	5	0.2	1 180	440	42 000	49 000	0.032
625	5	16	5	0.3	1 600	620	37 000	44 000	0.048
626	6	19	6	0.3	2 100	800	34 000	40 000	0.081
627	7	22	7	0.3	3 000	1 260	32 000	37 000	0.130
628	8	24	8	0.3	3 600	1 430	31 000	36 000	0.170
629	9	26	8	0.6	4 100	1 800	30 000	35 000	0.200



2RS

ZZ

Bearing No.	Boundary dimensions(mm)			r(mm)	Cr(N)	Cor(N)	Limiting Speed (min-1)		Mass (Kg)
	d	D	B				Grease	Oil	
633	3	13	5	0.2	1170	360	51 000	60 000	0.040
634	4	16	5	0.3	1 600	620	37 000	44 000	0.051
635	5	19	6	0.3	2 070	800	34 000	40 000	0.080
636	6	22	7	0.3	3 000	1 060	33 000	39 000	0.012
637	7	26	9	0.3	4 050	1 450	28 000	33 000	0.025
638	8	28	9	0.3	4 100	1 450	27 500	32 000	0.028
639	9	30	10	0.6	4 600	1 620	25 000	30 000	0.035
673	3	6	2	0.08	220	85	60 000	71 000	0.200
674	4	7	2	0.08	200	80	54 000	63 000	0.280
675	5	8	2	0.08	200	80	49 000	57 000	0.320
676	6	10	2.5	0.1	420	175	43 000	51 000	0.650
677	7	11	2.5	0.1	500	240	40 000	47 000	0.670
678	8	12	2.5	0.1	470	230	38 000	45 000	0.750
679	9	14	3	0.1	850	420	36 000	42 000	1.400

## Miniature Ball Bearings

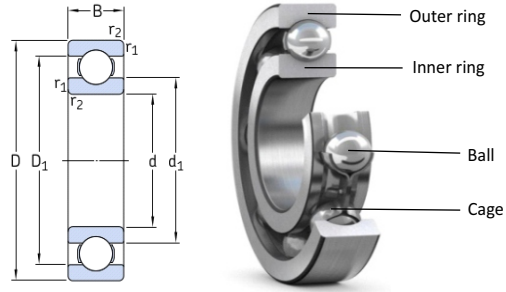

Bearing No.	Boundary dimensions(mm)			r(mm)	Cr(N)	Cor(N)	Limiting Speed (min <sup>-1</sup> )		Mass (Kg)
	d	D	B				Grease	Oil	
681	1	3	1	0.05	75	20	120 000	140 000	0.050
682	2	5	1.5	0.08	150	45	74 000	87 000	0.130
683	3	7	2	0.1	350	120	58 000	68 000	0.330
684	4	9	2.5	0.15	580	200	49 000	57 000	0.670
685	5	11	3	0.15	650	250	43 000	51 000	1.100
686	6	13	3.5	0.15	980	400	39 000	46 000	1.900
687	7	14	3.5	0.15	1 050	450	37 000	44 000	2.100
688	8	16	4	0.2	1 450	650	35 000	41 000	3.100
689	9	17	4	0.2	1 550	740	33 000	39 000	3.200
691	1	4	1.6	0.1	140	40	96 000	110 000	0.110
692	2	6	2.3	0.15	250	80	67 000	79 000	0.310
693	3	8	3	0.15	500	160	54 000	63 000	0.610
694	4	11	4	0.15	640	250	45 000	52 000	1.800
695	5	13	4	0.2	980	390	40 000	47 000	2.400
696	6	15	5	0.2	1 200	480	37 000	44 000	3.800
697	7	17	5	0.3	1 450	650	35 000	41 000	5.200
698	8	19	6	0.3	1 800	780	33 000	39 000	7.300
699	9	20	6	0.3	2 200	980	32 000	38 000	8.200



Bearing No.	Boundary dimensions(mm)			r(mm)	Cr(N)	Cor(N)	Limiting Speed (min-1)		Mass (Kg)
	d	D	B				Grease	Oil	
MR 104	4	10	4	0.15	650	230	59 000	70 000	0.001
MR 105	5	10	3	0.15	400	120	60 000	71 000	0.001
MR 106	6	10	3	0.15	450	160	54 000	64 000	0.001
MR 115	5	11	4	0.2	400	140	58 000	68 000	0.002
MR 117	7	11	3	0.2	400	150	50 000	59 000	0.001
MR 126	6	12	3	0.2	650	225	50 000	59 000	0.002
MR 128	8	12	3.5	0.2	500	200	46 000	54 000	0.001
MR 137	7	13	4	0.3	500	200	45 000	53 000	0.002
MR 148	8	14	4	0.3	750	300	42 000	50 000	0.002
MR 52	2	5	2	0.15	150	55	94 000	111 000	0.001
MR 62	2	6	2.5	0.15	300	100	86 000	101 000	0.001
MR 63	3	6	2.5	0.12	200	70	81 000	95 000	0.001
MR 72	2	7	2.5	0.15	350	120	76 000	90 000	0.001
MR 74	4	7	2.5	0.15	280	100	70 000	82 000	0.001
MR 83	3	8	3	0.15	350	130	67 000	79 000	0.001
MR 84	4	8	3	0.15	360	130	67 000	80 000	0.001
MR 85	5	8	2.5	0.2	280	120	62 000	74 000	0.001
MR 93	3	9	4	0.15	500	180	66 000	78 000	0.001
MR 95	5	9	3	0.2	400	150	60 000	71 000	0.001



**ASB<sup>®</sup>** | 



**Angular  
Contact  
Ball  
Bearings** | 

# Single Row Angular Contact Ball Bearings

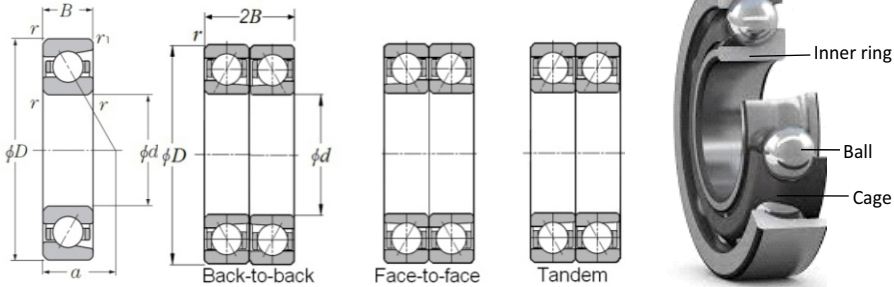

Bearing No.	Boundary dimensions(mm)			r(mm)	Cr(N)	Cor(N)	Limiting Speed (min-1)		Mass (Kg)
	d	D	B				Grease	Oil	
7000	10	26	8	0.3	5 000	2 340	23 000	31 000	0.019
7000C	10	26	8	0.3	5 350	2 500	44 000	61 000	0.019
7001	12	28	8	0.3	5 050	2 710	22 000	29 000	0.021
7001C	12	28	8	0.3	5 800	2 910	40 000	55 000	0.021
7002	15	32	9	0.3	6 150	3 400	18 000	24 000	0.030
7002C	15	32	9	0.3	6 650	3 700	34 000	47 000	0.030
7003	17	35	10	0.3	6 400	3 800	17 000	22 000	0.039
7003C	17	35	10	0.3	7 000	4 150	31 000	42 000	0.039
7004	20	42	12	0.6	10 300	6 050	15 000	20 000	0.069
7004C	20	42	12	0.6	11 200	6 600	26 000	35 000	0.069
7005	25	47	12	0.6	11 300	7 400	13 000	17 000	0.080
7005C	25	47	12	0.6	12 900	8 650	22 000	31 000	0.080
7006	30	55	13	1	14 500	10 100	12 000	14 000	0.117
7006C	30	55	13	1	16 000	11 100	19 000	26 000	0.117
7007	35	62	14	1	17 500	12 600	9 500	13 000	0.157
7007C	35	62	14	1	19 300	13 700	16 000	23 000	0.157
7008	40	68	15	1	18 800	14 500	8 500	11 000	0.190
7008C	40	68	15	1	20 700	16 000	15 000	20 000	0.190
7009	45	75	16	1	22 200	17 600	7 500	10 000	0.230
7009C	45	75	16	1	24 600	19 400	13 000	18 000	0.230
7010	50	80	16	1	23 600	20 000	7 000	9 200	0.250
7010C	50	80	16	1	26 200	22 000	12 000	17 000	0.250
7011	55	90	18	1.1	31 000	26 200	6 300	8 500	0.370
7011C	55	90	18	1.1	34 500	28 800	11 000	15 000	0.370
7012	60	95	18	1.1	32 000	28 000	6 000	7 600	0.400
7012C	60	95	18	1.1	35 500	30 500	10 000	14 000	0.400
7013	65	100	18	1.1	33 500	31 000	5 600	7 100	0.420
7013C	65	100	18	1.1	37 500	34 500	9 700	13 000	0.420
7014	70	110	20	1.1	42 500	39 500	5 000	6 600	0.590
7014C	70	110	20	1.1	47 000	43 000	8 900	12 000	0.590
7015	75	115	20	1.1	43 500	41 500	4 800	6 300	0.620
7015C	75	115	20	1.1	48 500	46 000	8 400	12 000	0.620
7016	80	125	22	1.1	53 500	50 500	4 400	5 800	0.840





Steel Cages



Polyamide Cages



Brass Cages

Bearing No.	Boundary dimensions(mm)			r(mm)	Cr(N)	Cor(N)	Limiting Speed (min-1)		Mass (Kg)
	d	D	B				Grease	Oil	
7016C	80	125	22	1.1	59 000	55 500	7 800	11 000	0.840
7017	85	130	22	1.1	54 500	53 500	4 100	5 500	0.890
7017C	85	130	22	1.1	60 500	59 000	7 400	10 000	0.890
7018	90	140	24	1.5	65 000	63 000	3 800	5 200	1.180
7018C	90	140	24	1.5	72 000	69 500	7 000	9 600	1.180
7019	95	145	24	1.5	67 000	66 500	3 800	5 200	1.200
7019C	95	145	24	1.5	74 000	73 500	6 700	9 200	1.200
7020	100	150	24	1.5	68 500	70 500	3 600	4 800	1.260
7020C	100	150	24	1.5	76 000	77 500	6 400	8 800	1.260
7021	105	160	26	2	80 000	81 500	3 300	4 400	1.580
7021C	105	160	26	2	97 000	97 500	6 000	8 300	1.580
7022	110	170	28	2	92 000	92 500	3 200	4 300	2.000
7022C	110	170	28	2	107 000	104 000	5 700	7 900	2.000
7024	120	180	28	2	96 500	103 000	2 900	3 800	2.130
7024C	120	180	28	2	109 000	112 000	5 300	7 300	2.130
7026	130	200	33	2	117 000	125 000	2 600	3 600	3.210
7026C	130	200	33	2	130 000	138 000	4 800	6 700	3.210
7028	140	210	33	2	120 000	133 000	2 400	3 300	3.400
7028C	140	210	33	2	133 000	146 000	4 600	6 300	3.400
7030	150	225	35	2.1	137 000	154 000	2 300	3 000	4.220
7030C	150	225	35	2.1	152 000	169 000	4 300	5 900	4.220
7032	160	240	38	2.1	155 000	176 000	2 100	2 800	5.100
7032C	160	240	38	2.1	172 000	194 000	4 000	5 500	5.100
7034	170	260	42	2.1	179 000	210 000	2 000	2 600	6.500
7034C	170	260	42	2.1	206 000	236 000	3 700	5 100	6.500
7036	180	280	46	2.1	207 000	252 000	1 900	2 500	8.800
7036C	180	280	46	2.1	235 000	290 000	3 500	4 800	8.800
7038	190	290	46	2.1	218 000	277 000	1 800	2 300	
7038C	190	290	46	2.1	248 000	310 000	3 300	4 600	
7040	200	310	51	2.1	226 000	277 000	1 700	2 200	14.400
7040C	200	310	51	2.1	274 000	360 000	3 100	4 300	14.400

# Single Row Angular Contact Ball Bearings

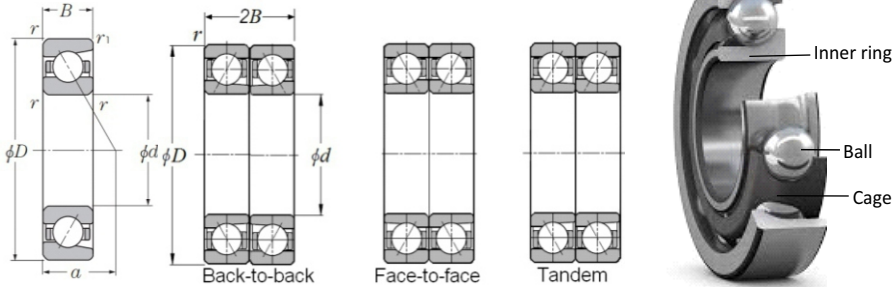

Bearing No.	Boundary dimensions(mm)			r(mm)	Cr(N)	Cor(N)	Limiting Speed (min-1)		Mass (Kg)
	d	D	B				Grease	Oil	
7200	10	30	9	0.6	5 400	2 710	22 000	30 000	0.030
7200B	10	30	9	0.6	5 150	2 570	19 000	28 000	0.030
7200C	10	30	9	0.6	6 950	3 300	40 000	55 000	0.030
7201	12	32	10	0.6	7 600	3 960	20 000	27 000	0.037
7201B	12	32	10	0.6	7 200	3 800	17 000	24 000	0.037
7201C	12	32	10	0.6	7 950	3 900	36 000	50 000	0.037
7202	15	35	11	0.6	9 050	4 700	17 000	23 000	0.046
7202B	15	35	11	0.6	8 600	4 500	16 000	21 000	0.046
7202C	15	35	11	0.6	8 700	4 550	32 000	44 000	0.046
7203	17	40	12	0.6	11 900	6 600	16 000	21 000	0.068
7203B	17	40	12	0.6	11 300	6 300	14 000	19 000	0.068
7203C	17	40	12	0.6	10 900	5 900	28 000	39 000	0.068
7204	20	47	14	1	14 500	8 300	13 000	18 000	0.108
7204B	20	47	14	1	13 700	7 850	11 000	16 000	0.108
7204C	20	47	14	1	14 700	8 150	24 000	33 000	0.108
7205	25	52	15	1	16 200	10 200	12 000	15 000	0.133
7205B	25	52	15	1	15 300	9 700	9 500	14 000	0.133
7205C	25	52	15	1	16 700	10 300	21 000	29 000	0.133
7206	30	62	16	1	22 500	14 800	10 000	13 000	0.200
7206B	30	62	16	1	21 200	13 900	8 500	12 000	0.200
7206C	30	62	16	1	23 200	14 900	18 000	24 000	0.200
7207	35	72	17	1.1	29 700	20 000	8 500	11 000	0.280
7207B	35	72	17	1.1	28 000	19 000	7 500	10 000	0.280
7207C	35	72	17	1.1	30 500	20 100	15 000	21 000	0.280
7208	40	80	18	1.1	35 000	25 200	7 500	10 000	0.370
7208B	40	80	18	1.1	33 000	23 700	6 700	9 200	0.370
7208C	40	80	18	1.1	36 500	25 400	13 000	18 000	0.370
7209	45	85	19	1.1	39 500	28 800	7 000	9 200	0.410
7209B	45	85	19	1.1	37 000	27 100	6 300	8 500	0.410
7209C	45	85	19	1.1	41 000	29 000	12 000	17 000	0.410
7210	50	90	20	1.1	41 000	31 500	6 300	8 500	0.460
7210B	50	90	20	1.1	38 500	29 600	5 600	7 500	0.460
7210C	50	90	20	1.1	43 000	32 000	11 000	16 000	0.460



Steel Cages



Polyamide Cages



Brass Cages

Bearing No.	Boundary dimensions(mm)			r(mm)	Cr(N)	Cor(N)	Limiting Speed (min-1)		Mass (Kg)
	d	D	B				Grease	Oil	
7211	55	100	21	1.5	51 000	39 500	6 000	7 500	0.610
7211B	55	100	21	1.5	48 000	37 500	5 300	7 000	0.610
7211C	55	100	21	1.5	53 000	40 000	10 000	14 000	0.610
7212	60	110	22	1.5	62 000	48 500	5 300	7 100	0.800
7212B	60	110	22	1.5	58 000	46 000	4 800	6 300	0.800
7212C	60	110	22	1.5	64 500	49 500	9 400	13 000	0.800
7213	65	120	23	1.5	70 000	57 800	4 900	6 500	1.020
7213B	65	120	23	1.5	66 000	54 500	4 300	5 600	1.020
7213C	65	120	23	1.5	73 500	59 000	8 600	12 000	1.020
7214	70	125	24	1.5	76 500	63 500	4 500	6 300	1.120
7214B	70	125	24	1.5	71 500	59 500	4 300	5 600	1.120
7214C	70	125	24	1.5	80 000	65 000	8 200	11 000	1.120
7215	75	130	25	1.5	79 000	68 500	4 300	5 800	1.210
7215B	75	130	25	1.5	74 000	64 000	4 000	5 300	1.210
7215C	75	130	25	1.5	83 500	70 000	7 800	11 000	1.210
7216	80	140	26	2	89 000	76 500	4 000	5 400	1.470
7216B	80	140	26	2	83 500	71 500	3 600	5 000	1.470
7216C	80	140	26	2	93 500	78 000	7 300	10 000	1.470
7217	85	150	28	2	103 000	89 500	3 800	5 000	1.850
7217B	85	150	28	2	96 500	83 500	3 400	4 500	1.850
7217C	85	150	28	2	100 000	85 000	6 800	9 400	1.850
7218	90	160	30	2	118 000	103 000	3 500	4 700	2.260
7218B	90	160	30	2	110 000	97 000	3 200	4 300	2.260
7218C	90	160	30	2	124 000	105 000	6 400	8 800	2.260
7219	95	170	32	2.1	126 000	112 000	3 400	4 500	2.770
7219B	95	170	32	2.1	120 000	105 000	3 000	4 000	2.770
7219C	95	170	32	2.1	133 000	115 000	6 000	8 300	2.770
7220	100	180	34	2.1	144 000	126 000	3 200	4 200	3.240
7220B	100	180	34	2.1	135 000	118 000	2 800	3 700	3.240
7220C	100	180	34	2.1	150 000	128 000	5 700	7 900	3.240
7221	105	190	36	2.1	157 000	141 000	3 000	4 000	3.820
7221B	105	190	36	2.1	147 000	135 000	2 700	3 600	3.820
7221C	105	190	36	2.1	163 000	144 000	5 400	7 500	3.820

# Single Row Angular Contact Ball Bearings

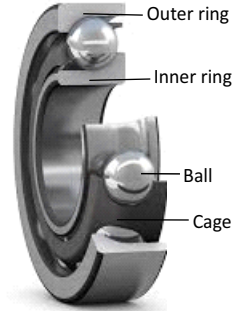
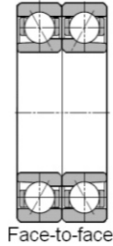
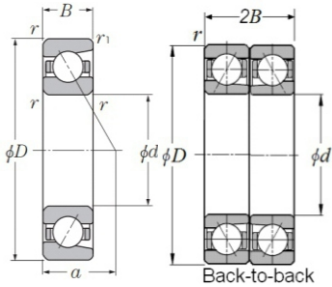

Bearing No.	Boundary dimensions(mm)			r(mm)	Cr(N)	Cor(N)	Limiting Speed (min-1)		Mass (Kg)
	d	D	B				Grease	Oil	
7222	110	200	38	2.1	170 000	158 000	2 800	3 800	4.470
7222B	110	200	38	2.1	159 000	149 000	2 600	3 400	4.470
7222C	110	200	38	2.1	171 000	157 000	5 200	7 100	4.470
7224	120	215	40	2.1	182 000	180 000	2 600	3 400	5.520
7224B	120	215	40	2.1	170 000	169 000	2 300	3 100	5.520
7224C	120	215	40	2.1	185 000	176 000	4 800	6 600	5.520
7226	130	230	40	3	196 000	198 000	2 400	3 100	6.150
7226B	130	230	40	3	184 000	185 000	2 100	2 800	6.150
7226C	130	230	40	3	214 000	216 000	4 400	6 100	6.150
7228	140	250	42	3	211 000	228 000	2 200	3 000	7.910
7228B	140	250	42	3	197 000	214 000	2 000	2 600	7.910
7228C	140	250	42	3	223 000	235 000	4 100	5 600	7.910
7230	150	270	45	3	249 000	280 000	2 000	2 800	10.800
7230B	150	270	45	3	223 000	246 000	1 800	2 600	10.800
7230C	150	270	45	3	261 000	287 000	3 800	5 200	10.800
7232	160	290	48	3	263 000	305 000	1 900	2 600	36.800
7232B	160	290	48	3	246 000	287 000	1 700	2 200	36.800
7232C	160	290	48	3	288 000	335 000	3 600	4 900	36.800
7234	170	310	52	4	272 000	330 000	1 800	2 400	16.700
7234B	170	310	52	4	254 000	310 000	1 600	2 200	16.700
7234C	170	310	52	4	299 000	360 000	3 300	4 600	16.700
7236	180	320	52	4	281 000	350 000	1 700	2 200	18.900
7236B	180	320	52	4	262 000	330 000	1 500	2 000	18.900
7236C	180	320	52	4	310 000	385 000	3 200	4 400	18.900
7238	190	340	55	4	315 000	410 000	1 600	2 200	22.600
7238B	190	340	55	4	294 000	385 000	1 400	2 000	22.600
7240	200	360	58	4	335 000	450 000	1 500	2 000	26.200
7240B	200	360	58	4	315 000	420 000	1 300	1 900	26.200



Steel Cages



Polyamide Cages



Brass Cages

Bearing No.	Boundary dimensions(mm)			r(mm)	Cr(N)	Cor(N)	Limiting Speed (min-1)		Mass (Kg)
	d	D	B				Grease	Oil	
7300	10	35	11	0.6	9 300	4 300	20 000	26 000	0.040
7300B	10	35	11	0.6	8 950	4 150	18 000	24 000	0.040
7300C	10	35	11	0.6	9 850	4 600	36 000	49 000	0.040
7301	12	37	12	1	11 200	5 250	18 000	24 000	0.080
7301B	12	37	12	1	10 800	5 050	16 000	22 000	0.080
7301C	12	37	12	1	10 800	4 900	33 000	45 000	0.080
7302	15	42	13	1	13 600	7 100	16 000	21 000	0.055
7302B	15	42	13	1	12 800	6 750	14 000	19 000	0.055
7302C	15	42	13	1	13 300	6 850	28 000	39 000	0.055
7303	17	47	14	1	15 900	8 650	14 000	19 000	0.118
7303B	17	47	14	1	15 200	8 250	13 000	17 000	0.118
7303C	17	47	14	1	15 900	8 350	25 000	34 000	0.118
7304	20	52	15	1.1	18 700	10 400	13 000	17 000	0.140
7304B	20	52	15	1.1	17 800	9 900	10 000	15 000	0.140
7304C	20	52	15	1.1	18 600	10 000	22 000	31 000	0.140
7305	25	62	17	1.1	26 400	15 800	10 000	14 000	0.220
7305B	25	62	17	1.1	25 100	15 100	8 500	12 000	0.220
7305C	25	62	17	1.1	26 600	15 500	18 000	25 000	0.220
7306	30	72	19	1.1	33 500	22 400	9 000	12 000	0.336
7306B	30	72	19	1.1	32 000	21 000	7 500	10 000	0.336
7306C	30	72	19	1.1	32 500	20 400	16 000	22 000	0.336
7307	35	80	21	1.5	40 000	26 300	8 000	10 000	0.450
7307B	35	80	21	1.5	37 500	24 900	7 000	9 500	0.450
7307C	35	80	21	1.5	40 500	26 000	14 000	19 000	0.450
7308	40	90	23	1.5	49 000	33 000	7 000	9 200	0.614
7308B	40	90	23	1.5	46 000	31 000	6 300	8 500	0.614
7308C	40	90	23	1.5	49 500	32 500	12 000	17 000	0.614
7309	45	100	25	1.5	63 500	43 500	6 300	8 500	0.798
7309B	45	100	25	1.5	60 000	41 500	5 600	7 500	0.798
7309C	45	100	25	1.5	63 500	43 500	11 000	15 000	0.798
7310	50	110	27	2	74 000	52 000	5 600	7 500	1.042
7310B	50	110	27	2	70 500	49 500	5 000	6 700	1.042
7310C	50	110	27	2	75 500	51 000	10 000	14 000	1.042

# Single Row Angular Contact Ball Bearings

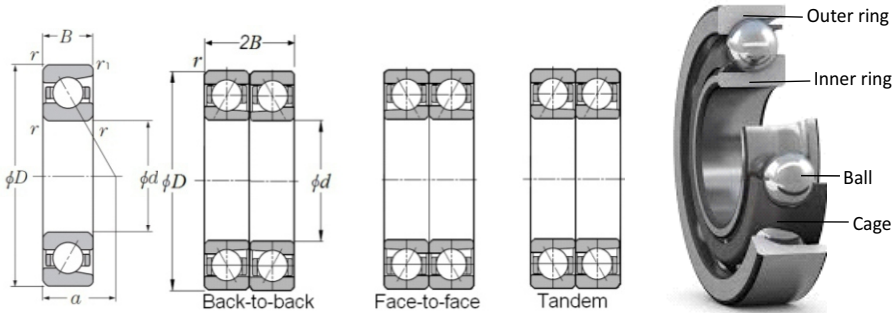

Bearing No.	Boundary dimensions(mm)			r(mm)	Cr(N)	Cor(N)	Limiting Speed (min-1)		Mass (Kg)
	d	D	B				Grease	Oil	
7311	55	120	29	2	85 500	61 500	5 000	7 000	1.368
7311B	55	120	29	2	81 000	58 000	4 500	6 200	1.368
7311C	55	120	29	2	87 000	60 000	9 100	13 000	1.368
7312	60	130	31	2.1	98 000	71 500	4 800	6 300	1.714
7312B	60	130	31	2.1	92 500	67 500	4 300	5 500	1.714
7312C	60	130	31	2.1	99 500	70 000	8 400	12 000	1.714
7313	65	140	33	2.1	111 000	82 000	4 400	5 800	2.070
7313B	65	140	33	2.1	105 000	77 500	4 000	5 300	2.070
7313C	65	140	33	2.1	113 000	81 000	7 800	11 000	2.070
7314	70	150	35	2.1	125 000	94 000	4 000	5 300	2.522
7314B	70	150	35	2.1	118 000	88 500	3 600	4 800	2.522
7314C	70	150	35	2.1	127 000	92 500	7 300	10 000	2.522
7315	75	160	37	2.1	136 000	106 000	3 800	5 000	3.038
7315B	75	160	37	2.1	128 000	100 000	3 400	4 500	3.038
7315C	75	160	37	2.1	138 000	104 000	6 800	9 400	3.038
7316	80	170	39	2.1	147 000	119 000	3 600	4 800	3.698
7316B	80	170	39	2.1	139 000	112 000	3 200	4 200	3.698
7316C	80	170	39	2.1	150 000	117 000	6 400	8 800	3.698
7317	85	180	41	3	159 000	133 000	3 400	4 500	4.322
7317B	85	180	41	3	150 000	125 000	3 000	4 000	4.322
7317C	85	180	41	3	162 000	131 000	6 000	8 300	4.322
7318	90	190	43	3	171 000	147 000	3 200	4 300	5.086
7318B	90	190	43	3	161 000	139 000	2 800	3 800	5.086
7318C	90	190	43	3	174 000	146 000	5 700	7 900	5.086
7319	95	200	45	3	183 000	163 000	3 000	4 000	5.800
7319B	95	200	45	3	172 000	153 000	2 500	3 600	5.800
7319C	95	200	45	3	186 000	161 000	5 400	7 500	5.800
7320	100	215	47	3	207 000	190 000	2 800	3 800	7.580
7320B	100	215	47	3	196 000	180 000	2 400	3 300	7.580
7320C	100	215	47	3	211 000	197 000	5 100	7 000	7.580
7321	105	225	49	3	219 000	206 000	2 700	3 600	8.200
7321B	105	225	49	3	208 000	196 000	2 400	3 200	8.200
7321C	105	225	49	3	224 000	212 000	4 800	6 700	8.200



Steel Cages



Polyamide Cages



Brass Cages

Bearing No.	Boundary dimensions(mm)			r(mm)	Cr(N)	Cor(N)	Limiting Speed (min-1)		Mass (Kg)
	d	D	B				Grease	Oil	
7322	110	240	50	3	244 000	239 000	2 600	3 400	10.404
7322B	110	240	50	3	231 000	227 000	2 200	3 000	10.404
7322C	110	240	50	3	237 000	227 000	4 600	6 300	10.404
7324	120	260	55	3	260 000	169 000	2 200	3 000	14.700
7324B	120	260	55	3	245 000	253 000	2 100	2 800	14.700
7326	130	280	58	4	300 000	330 000	2 200	2 900	17.600
7326B	130	280	58	4	284 000	310 000	1 900	2 600	17.600
7328	140	300	62	4	300 000	335 000	2 000	2 600	21.500
7328B	140	300	62	4	284 000	315 000	1 700	2 400	21.500
7330	150	320	65	4	330 000	380 000	1 700	2 400	25.100
7330B	150	320	65	4	310 000	360 000	1 500	2 200	25.100
7332	160	340	68	4	345 000	420 000	1 700	2 200	31.200
7332B	160	340	68	4	325 000	395 000	1 500	2 000	31.200
7334	170	360	72	4	390 000	485 000	1 600	2 200	36.700
7334B	170	360	72	4	365 000	460 000	1 400	2 000	36.700
7336	180	380	75	4	410 000	535 000	1 400	2 000	42.700
7336B	180	380	75	4	385 000	505 000	1 300	1 900	42.700
7338	190	400	78	5	445 000	610 000	1 400	1 900	48.000
7338B	190	400	78	5	420 000	575 000	1 300	1 800	48.000
7340	200	420	80	5	475 000	655 000	1 300	1 800	55.800
7340B	200	420	80	5	445 000	620 000	1 200	1 700	55.800

## Single Row Angular Contact Ball Bearings

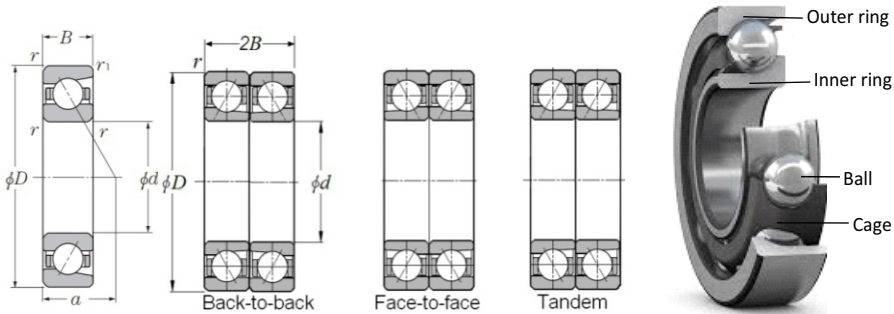

Bearing No.	Boundary dimensions(mm)			r(mm)	Cr(N)	Cor(N)	Limiting Speed (min-1)		Mass (Kg)
	d	D	B				Grease	Oil	
7406B	30	90	23	1.5	51 400	30 100	6 000	8 000	0.900
7407B	35	100	25	1.5	60 200	37 900	5 000	7 500	1.100
7408B	40	110	27	1.5	70 100	49 100	5 000	6 500	1.350
7409B	45	120	29	2	80 700	44 100	4 500	6 000	1.750
7410B	50	130	31	2.1	105 300	71 200	4 000	5 500	2.100
7411B	55	140	33	2.1	110 000	76 300	3 800	5 200	2.550
7412B	60	150	35	2.1	119 300	86 100	3 500	4 700	3.200
7413B	65	160	37	2.1	128 700	96 400	3 200	4 500	4.000
7414B	70	180	42	3	138 700	109 600	3 000	4 200	5.550
7415B	75	190	45	3	148 400	120 400	2 800	4 000	6.800
7416B	80	200	48	3	158 400	132 400	2 600	3 700	8.180
7417B	85	210	52	4	168 600	145 000	2 400	3 400	9.300
7418B	90	225	54	4	179 100	159 200	2 300	3 200	10.800





Steel Cages



Polyamide Cages



Brass Cages

Bearing No.	Boundary dimensions(mm)			r(mm)	Cr(N)	Cor(N)	Limiting Speed (min-1)		Mass (Kg)
	d	D	B				Grease	Oil	
7901C	12	24	6	0.3	3 300	1 800	28 000	36 000	0.011
7902C	15	28	7	0.3	4 700	2 600	24 000	32 000	0.015
7903C	17	30	7	0.3	5 000	2 800	22 000	30 000	0.017
7904C	20	37	9	0.3	6 800	4 200	20 000	28 000	0.035
7905C	25	42	9	0.3	7 800	5 400	18 000	26 000	0.042
7906C	30	47	9	0.3	8 200	6 200	16 000	24 000	0.048
7907C	35	55	10	0.6	12 000	9 100	14 000	22 000	0.075
7908C	40	62	12	0.6	14 500	10 600	12 000	20 000	0.110
7909C	45	68	12	0.6	16 000	12 600	10 000	18 000	0.130
7910C	50	72	12	0.6	16 500	15 000	8 000	16 000	0.140
7911C	55	80	13	1	19 100	17 800	7 500	15 000	0.183
7912C	60	85	13	1	19 500	18 500	7 000	14 000	0.198
7913C	65	90	13	1	20 300	20 500	6 500	13 000	0.212
7914C	70	100	16	1	28 100	27 500	6 300	12 000	0.342
7915C	75	105	16	1	28 600	29 200	6 000	10 000	0.360
7916C	80	116	16	1	29 000	30 500	5 500	10 000	0.381
7917C	85	120	18	1.1	39 000	40 500	5 000	9 000	0.542
7918C	90	125	18	1.1	41 200	46 000	5 000	8 500	0.560
7919C	95	130	18	1.1	42 500	48 000	4 500	8 500	0.604
7920C	100	140	20	1.1	48 500	52 000	4 300	8 200	0.808
7921C	105	145	20	1.1	51 000	57 000	4 000	8 000	0.830
7922C	110	150	20	1.1	52 000	58 000	3 800	7 500	0.880
7924C	120	165	22	1.1	72 000	80 100	3 600	7 200	1.150
7926C	130	180	24	1.5	77 500	90 100	3 400	7 000	1.540
7928C	140	190	24	1.5	79 500	95 500	3 200	6 800	1.640
7930C	150	210	28	2	102 000	122 000	3 000	6 500	2.970
7932C	160	220	28	2	145 600	167 400	2 800	6 300	3.120

## Double Row Angular Contact Ball Bearings

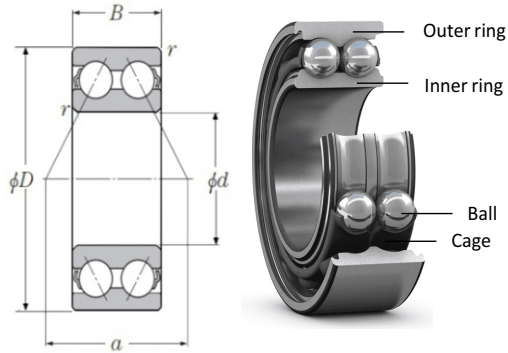

Bearing No.	Boundary dimensions(mm)			r(mm)	Cr(N)	Cor(N)	Limiting Speed (min-1)		Mass (Kg)
	d	D	B				Grease	Oil	
3200	10	30	14.3	0.6	8 400	6 500	14 000	19 000	0.050
3201	12	32	15.9	0.6	8 450	6 700	13 000	17 000	0.060
3202	15	35	15.9	0.6	11 000	9 000	11 000	15 000	0.069
3203	17	40	17.5	0.6	14 000	11 800	9 900	13 000	0.099
3204	20	47	20.6	1	17 500	15 000	8 800	12 000	0.166
3205	25	52	20.6	1	19 300	18 000	7 300	9 800	0.183
3206	30	62	23.8	1	27 700	27 400	6 300	8 400	0.303
3207	35	72	27	1.1	37 500	38 000	5 500	7 400	0.458
3208	40	80	30.2	1.1	40 500	45 000	4 900	6 600	0.627
3209	45	85	30.2	1.1	46 500	52 000	4 400	5 900	0.678
3210	50	90	30.2	1.5	52 500	60 000	4 000	5 300	0.698
3211	55	100	33.3	1.5	66 000	76 200	3 600	4 900	1.070
3212	60	110	36.5	1.5	70 500	88 000	3 400	4 500	1.340
3213	65	120	38.1	1.5	78 000	99 000	3 100	4 200	1.680
3214	70	125	39.7	1.5	86 000	110 000	2 900	3 900	1.840
3215	75	130	41.3	1.5	94 000	122 000	2 700	3 600	2.000
3216	80	140	44.4	2	104 000	130 000	2 500	3 400	2.710
3217	85	150	49.2	2	121 000	155 000	2 400	3 200	3.480
3218	90	160	52.4	2	135 000	170 000	2 200	3 000	4.240
3219	95	170	55.6	2.1	144 000	184 000	2 100	2 800	5.100
3220	100	180	60.3	2.1	189 000	234 000	2 000	2 700	5.880



Open



ZZ

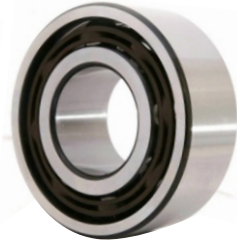

Polyamide Cages

Bearing No.	Boundary dimensions(mm)			r(mm)	Cr(N)	Cor(N)	Limiting Speed (min-1)		Mass (Kg)
	d	D	B				Grease	Oil	
3302	15	42	19	1	14 200	11 700	9 900	13 000	0.127
3303	17	47	22.2	1	17 500	15 000	9 000	12 000	0.185
3304	20	52	22.2	1.1	21 000	18 500	8 000	11 000	0.221
3305	25	62	25.4	1.1	29 400	26 800	6 700	8 900	0.354
3306	30	72	30.2	1.1	39 000	36 500	5 700	7 600	0.558
3307	35	80	34.9	1.5	49 500	47 500	5 000	6 600	0.756
3308	40	90	36.5	1.5	54 500	57 500	4 400	5 900	1.030
3309	45	100	39.7	1.5	67 500	72 500	4 000	5 300	1.370
3310	50	110	44.4	2	81 500	89 500	3 600	4 800	1.980
3311	55	120	49.2	2	96 500	108 000	3 300	4 400	2.420
3312	60	130	54	2.1	113 000	128 000	3 000	4 000	3.070
3313	65	140	58.7	2.1	131 000	150 000	2 800	3 700	3.900
3314	70	150	63.5	2.1	153 000	168 000	2 600	3 500	5.200
3315	75	160	68.3	2.1	172 000	191 000	2 400	3 200	6.300

## Double Row Angular Contact Ball Bearings

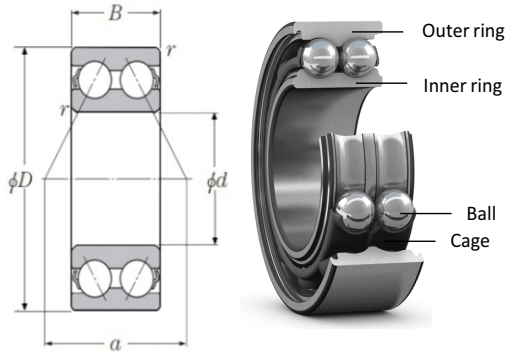

Bearing No.	Boundary dimensions(mm)			r(mm)	Cr(N)	Cor(N)	Limiting Speed (min-1)		Mass (Kg)
	d	D	B				Grease	Oil	
5200	10	30	14.3	0.6	6 950	3 800	14 000	19 000	0.049
5201	12	32	15.9	0.6	9 150	5 000	13 000	17 000	0.057
5202	15	35	15.9	0.6	10 000	6 000	11 000	15 000	0.064
5203	17	40	17.5	0.6	12 800	7 900	9 900	13 000	0.096
5204	20	47	20.6	1	19 000	12 100	8 800	12 000	0.153
5205	25	52	20.6	1	20 500	14 300	7 300	9 800	0.175
5206	30	62	23.8	1	28 500	20 400	6 300	8 400	0.286
5207	35	72	27	1.1	38 000	27 800	5 500	7 400	0.436
5208	40	80	30.2	1.1	42 500	32 500	4 900	6 600	0.590
5209	45	85	30.2	1.1	48 000	37 000	4 400	5 900	0.640
5210	50	90	30.2	1.5	51 000	42 000	4 000	5 300	0.689
5211	55	100	33.3	1.5	63 000	53 000	3 600	4 900	0.986
5212	60	110	36.5	1.5	71 500	58 500	3 400	4 500	1.270
5213	65	120	38.1	1.5	83 500	72 500	3 100	4 200	1.570
5214	70	125	39.7	1.5	90 500	79 500	2 900	3 900	1.800
5215	75	130	41.3	1.5	90 000	80 500	2 700	3 600	1.900
5216	80	140	44.4	2	106 000	95 500	2 500	3 400	2.390
5217	85	150	49.2	2	112 000	106 000	2 400	3 200	3.060
5218	90	160	52.4	2	140 000	129 000	2 200	3 000	3.730



Open



ZZ



Polyamide Cages

Bearing No.	Boundary dimensions(mm)			r(mm)	Cr(N)	Cor(N)	Limiting Speed (min-1)		Mass (Kg)
	d	D	B				Grease	Oil	
5302	15	42	19	1	17 200	10 100	9 900	13 000	0.132
5303	17	47	22.2	1	20 400	12 100	9 000	12 000	0.181
5304	20	52	22.2	1.1	20 600	12 700	8 000	11 000	0.217
5305	25	62	25.4	1.1	30 500	20 500	6 700	8 900	0.362
5306	30	72	30.2	1.1	39 500	27 500	5 700	7 600	0.553
5307	35	80	34.9	1.5	49 500	35 000	5 000	6 600	0.766
5308	40	90	36.5	1.5	60 500	44 000	4 400	5 900	1.010
5309	45	100	39.7	1.5	72 500	54 000	4 000	5 300	1.340
5310	50	110	44.4	2	85 500	64 500	3 600	4 800	1.810
5311	55	120	49.2	2	106 000	82 000	3 300	4 400	2.320
5312	60	130	54	2.1	122 000	95 500	3 000	4 000	3.050
5313	65	140	58.7	2.1	138 000	109 000	2 800	3 700	3.960
5314	70	150	63.5	2.1	155 000	125 000	2 600	3 500	4.740
5315	75	160	68.3	2.1	168 000	141 000	2 400	3 200	5.650

## Four - Point Contact Ball Bearings

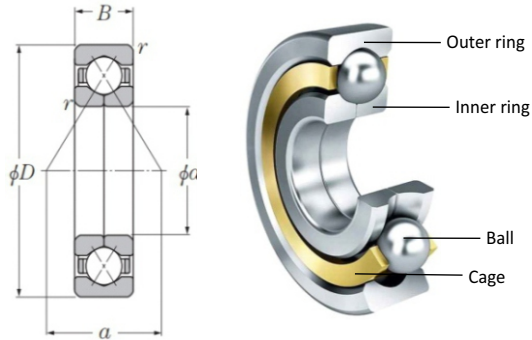

Bearing No.	Boundary dimensions(mm)			r(mm)	Cr(N)	Cor(N)	Limiting Speed (min <sup>-1</sup> )		Mass (Kg)
	d	D	B				Grease	Oil	
QJ 202MA	15	35	11	0.6	12 700	8 300	-	21 000	0.042
QJ 203MA	17	40	12	0.6	17 000	11 400	-	19 000	0.082
QJ 205MA	25	52	15	1	27 000	21 200	-	14 000	0.160
QJ 206MA	30	62	16	1	37 500	30 500	-	12 000	0.240
QJ 208MA	40	80	18	1.1	56 000	49 000	-	9 000	0.450
QJ 209MA	45	85	19	1.1	63 000	56 000	-	8 500	0.520
QJ 210MA	50	90	20	1.1	65 500	61 000	-	7 500	0.590
QJ 211MA	55	100	21	1.5	85 000	83 000	-	7 000	0.770
QJ 212MA	60	110	22	1.5	96 500	93 000	-	6 300	0.990
QJ 213MA	65	120	23	1.5	110 000	112 000	-	5 600	1.200
QJ 214MA	70	125	24	1.5	120 000	122 000	-	5 600	1.300
QJ 215MA	75	130	25	1.5	125 000	132 000	-	5 300	1.450
QJ 216MA	80	140	26	2	146 000	156 000	-	4 800	1.850
QJ 217MA	85	150	28	2	156 000	173 000	-	4 500	2.250
QJ 218MA	90	160	30	2	186 000	200 000	-	4 300	2.750
QJ 219MA	95	170	32	2.1	212 000	232 000	-	4 000	3.350
QJ 220MA	100	180	34	2.1	236 000	265 000	-	3 800	4.050
QJ 222MA	110	200	38	2.1	280 000	325 000	-	3 400	5.600
QJ 224MA	120	215	40	2.1	300 000	365 000	-	3 200	6.950
QJ 226MA	130	230	40	3	310 000	400 000	-	2 800	7.750
QJ 228MA	140	250	42	3	345 000	475 000	-	2 600	9.850
QJ 230MA	150	270	45	3	400 000	570 000	-	2 400	12.500



Brass Cage

Bearing No.	Boundary dimensions(mm)			r(mm)	Cr(N)	Cor(N)	Limiting Speed (min-1)		Mass (Kg)
	d	D	B				Grease	Oil	
QJ 303MA	17	47	14	1	23 400	15 000	-	17 000	0.140
QJ 304MA	20	52	15	1.1	32 000	21 600	-	15 000	0.180
QJ 305MA	25	62	17	1.1	42 500	30 000	-	13 000	0.320
QJ 306MA	30	72	19	1.1	53 000	41 500	-	10 000	0.420
QJ 307MA	35	80	21	1.5	64 000	51 000	-	9 500	0.570
QJ 308MA	40	90	23	1.5	78 000	64 000	-	8 500	0.780
QJ 309MA	45	100	25	1.5	100 000	83 000	-	7 500	1.050
QJ 310MA	50	110	27	2	118 000	100 000	-	6 700	1.350
QJ 311MA	55	120	29	2	137 000	118 000	-	6 000	1.750
QJ 312MA	60	130	31	2.1	156 000	137 000	-	5 600	2.150
QJ 313MA	65	140	33	2.1	176 000	156 000	-	5 300	2.700
QJ 314MA	70	150	35	2.1	200 000	180 000	-	4 800	3.150
QJ 315MA	75	160	37	2.1	216 000	200 000	-	4 500	3.900
QJ 316MA	80	170	39	2.1	232 000	228 000	-	4 300	4.600
QJ 317MA	85	180	41	3	250 000	255 000	-	4 000	5.450
QJ 318MA	90	190	43	3	285 000	305 000	-	3 800	6.450
QJ 319MA	95	200	45	3	305 000	340 000	-	3 600	7.450
QJ 320MA	100	215	47	3	345 000	400 000	-	3 400	9.300
QJ 322MA	110	240	50	3	390 000	480 000	-	3 000	12.500
QJ 324MA	120	260	55	3	415 000	530 000	-	2 800	16.000
QJ 326MA	130	280	58	4	455 000	610 000	-	2 600	19.500
QJ 328MA	140	300	62	4	500 000	695 000	-	2 400	24.000
QJ 330MA	150	320	65	4	530 000	765 000	-	2 200	29.000





**ASB<sup>®</sup>** | 



**Self Aligning  
Ball  
Bearings** | 

## Self Aligning Ball Bearings

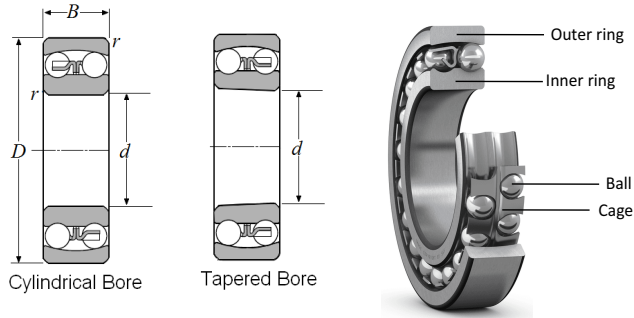

Bearing No.	Boundary dimensions(mm)			r(mm)	Cr(N)	Cor(N)	Limiting Speed (min-1)		Mass (Kg)
	d	D	B				Grease	Oil	
1200	10	30	9	0.6	5 500	1 200	23 000	28 000	0.036
1201	12	32	10	0.6	5 600	1 250	21 000	26 000	0.042
1202	15	35	11	0.6	7 450	1 750	18 000	22 000	0.052
1203	17	40	12	0.6	7 900	2 000	16 000	20 000	0.076
1204	20	47	14	1	9 900	2 600	14 000	17 000	0.122
1205	25	52	15	1	12 100	3 300	12 000	14 000	0.146
1206	30	62	16	1	15 600	4 650	9 900	12 000	0.224
1207	35	72	17	1.1	15 800	5 100	8 500	10 000	0.334
1208	40	80	18	1.1	19 200	6 500	7 500	9 200	0.420
1209	45	85	19	1.1	21 800	7 350	7 000	8 500	0.474
1210	50	90	20	1.1	22 700	8 100	6 500	7 900	0.525
1211	55	100	21	1.5	26 800	10 000	5 800	7 100	0.714
1212	60	110	22	1.5	30 200	11 500	5 200	6 400	0.916
1213	65	120	23	1.5	31 000	12 500	4 800	5 800	1.152
1214	70	125	24	1.5	34 600	13 800	4 600	5 700	1.260
1215	75	130	25	1.5	38 800	15 700	4 300	5 300	1.374
1216	80	140	26	2	39 800	17 000	4 000	4 900	1.678
1217	85	150	28	2	49 200	20 800	3 800	4 600	2.118
1218	90	160	30	2	56 800	23 400	3 500	4 300	2.500
1219	95	170	32	2.1	57 000	24 300	3 300	4 000	3.100
1220	100	180	34	2.1	69 000	29 700	3 100	3 800	3.700
1221	105	190	36	2.1	77 000	34 000	2 900	3 600	4.400
1222	110	200	38	2.1	80 200	35 200	2 800	3 400	5.150



Steel Cages



Brass Cages

Bearing No.	Boundary dimensions(mm)			r(mm)	Cr(N)	Cor(N)	Limiting Speed (min-1)		Mass (Kg)
	d	D	B				Grease	Oil	
1301	12	37	12	1	9 400	2 150	18 000	22 000	0.067
1302	15	42	13	1	9 550	2 300	16 000	20 000	0.096
1303	17	47	14	1	12 500	3 200	14 000	17 000	0.126
1304	20	52	15	1.1	12 400	3 300	13 000	15 000	0.166
1305	25	62	17	1.1	18 000	5 000	9 900	12 000	0.264
1306	30	72	19	1.1	21 300	6 300	8 700	11 000	0.392
1307	35	80	21	1.5	25 100	7 850	7 600	9 300	0.522
1308	40	90	23	1.5	29 500	9 700	6 900	8 400	0.726
1309	45	100	25	1.5	38 100	12 700	6 100	7 500	0.976
1310	50	110	27	2	43 400	14 100	5 600	6 800	1.232
1311	55	120	29	2	51 300	17 900	5 000	6 200	1.630
1312	60	130	31	2.1	57 200	20 800	4 500	5 500	1.964
1313	65	140	33	2.1	61 700	22 900	4 300	5 200	2.474
1314	70	150	35	2.1	74 000	27 700	4 000	4 900	3.000
1315	75	160	37	2.1	78 900	29 900	4 000	4 900	3.620
1316	80	170	39	2.1	88 100	33 100	3 500	4 300	4.244
1317	85	180	41	3	97 300	37 800	3 300	4 000	5.038
1318	90	190	43	3	116 000	44 400	3 100	3 800	5.800
1319	95	200	45	3	132 000	50 800	2 900	3 600	6.700
1320	100	215	47	3	143 000	57 300	2 800	3 400	8.300
1321	105	225	49	3	149 000	60 200	2 600	3 200	10.000
1322	110	240	50	3	150 000	63 200	2 400	3 000	12.000

## Self Aligning Ball Bearings

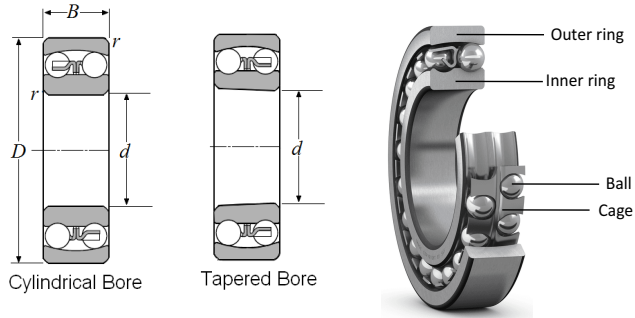

Bearing No.	Boundary dimensions(mm)			r(mm)	Cr(N)	Cor(N)	Limiting Speed (min <sup>-1</sup> )		Mass (Kg)
	d	D	B				Grease	Oil	
2200	10	30	14	0.6	7 400	1 600	23 000	29 000	0.050
2201	12	32	14	0.6	7 650	1 750	21 000	26 000	0.056
2202	15	35	14	0.6	7 700	1 850	18 000	22 000	0.062
2203	17	40	16	0.6	9 800	2 400	16 000	20 000	0.094
2204	20	47	18	1	12 600	3 300	14 000	17 000	0.146
2205	25	52	18	1	12 600	3 500	12 000	15 000	0.164
2206	30	62	20	1	15 600	4 650	10 000	12 000	0.268
2207	35	72	23	1.1	21 600	6 600	8 500	10 000	0.400
2208	40	80	23	1.1	22 400	7 400	7 600	9 300	0.510
2209	45	85	23	1.1	23 300	8 150	7 000	8 500	0.550
2210	50	90	23	1.1	23 300	8 500	6 500	7 900	0.592
2211	55	100	25	1.5	26 800	10 000	5 800	7 100	0.816
2212	60	110	28	1.5	34 100	12 600	5 300	6 500	1.126
2213	65	120	31	1.5	43 500	16 400	4 900	5 900	1.492
2214	70	125	31	1.5	43 900	17 100	4 600	5 600	1.566
2215	75	130	31	1.5	44 200	17 800	4 300	5 300	1.634
2216	80	140	33	2	49 000	19 900	4 100	5 000	2.058
2217	85	150	36	2	58 300	23 600	3 800	4 600	2.574
2218	90	160	40	2	67 700	27 200	3 500	4 300	3.252
2219	95	170	43	2.1	82 700	34 300	3 300	4 000	4.100
2220	100	180	46	2.1	80 900	34 000	3 100	3 800	4.720
2221	105	190	50	2.1	94 900	40 100	3 000	3 600	6.070
2222	110	200	53	2.1	120 000	48 900	2 800	3 400	6.853



Steel Cages



Brass Cages

Bearing No.	Boundary dimensions(mm)			r(mm)	Cr(N)	Cor(N)	Limiting Speed (min-1)		Mass (Kg)
	d	D	B				Grease	Oil	
2301	12	37	17	1	9 700	2 300	16 000	22 000	0.095
2302	15	42	17	1	12 100	2 900	14 000	20 000	0.120
2303	17	47	19	1	14 500	3 600	13 000	18 000	0.160
2304	20	52	21	1.1	18 000	4 700	11 000	15 000	0.222
2305	25	62	24	1.1	24 400	6 600	9 400	13 000	0.342
2306	30	72	27	1.1	31 400	8 750	8 000	11 000	0.502
2307	35	80	31	1.5	39 400	11 300	7 100	9 800	0.682
2308	40	90	33	1.5	44 900	13 500	6 200	8 600	0.940
2309	45	100	36	1.5	54 400	16 700	5 600	7 700	1.246
2310	50	110	40	2	64 600	20 300	5 100	7 000	1.676
2311	55	120	43	2	75 300	24 000	4 600	6 400	2.116
2312	60	130	46	2.1	87 200	28 300	4 200	5 800	2.632
2313	65	140	48	2.1	95 800	32 500	3 800	5 300	3.128
2314	70	150	51	2.1	89 600	31 700	3 600	4 900	3.946
2315	75	160	55	2.1	103 000	36 800	3 400	4 600	4.700
2316	80	170	58	2.1	129 000	45 700	3 100	4 300	6.100
2317	85	180	60	3	141 000	51 500	3 000	4 100	6.600
2318	90	190	64	3	153 000	57 900	2 800	3 900	8.450
2319	95	200	67	3	166 000	64 800	2 700	3 700	9.800
2320	100	215	73	3	183 000	73 400	2 400	3 400	12.500
2321	105	225	77	3	187 000	78 000	2 300	3 200	14.300
2322	110	240	80	3	200 000	85 700	2 200	3 000	17.300



**ASB<sup>®</sup>** | 



**Cylindrical  
Roller  
Bearings** | 

# Cylindrical Roller Bearings

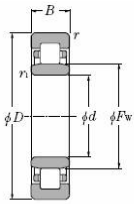

Type NU



Type NJ



Type NUP



Type N



Type NF

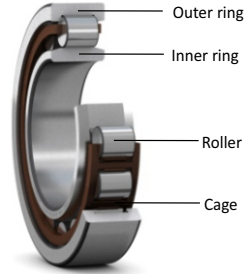

Bearing No. N NF NU NJ NUP	Boundary dimensions(mm)			r(mm)	Cr(N)	Cor(N)	Limiting Speed (min <sup>-1</sup> )		Mass (Kg)
	d	D	B				Grease	Oil	
1005	25	47	12	0.6	12 200	11 200	15 000	18 000	0.089
1006	30	55	13	1	16 800	16 600	12 000	15 000	0.125
1007	35	62	14	1	19 200	19 700	11 000	13 000	0.160
1008	40	68	15	1	23 200	24 600	10 000	12 000	0.200
1009	45	75	16	1	27 600	30 200	9 000	11 000	0.250
1010	50	80	16	1	27 200	30 600	8 500	10 000	0.270
1011	55	90	18	1.1	32 000	37 400	7 500	9 000	0.400
1012	60	95	18	1.1	34 000	41 200	6 700	8 500	0.450
1013	65	100	18	1.1	34 900	43 500	6 300	8 000	0.480
1014	70	110	20	1.1	49 800	60 000	6 000	7 100	0.620
1015	75	115	20	1.1	51 000	63 200	5 600	6 700	0.740
1016	80	125	22	1.1	59 000	73 500	5 300	6 300	1.000
1017	85	130	22	1.1	63 000	81 200	5 000	6 000	1.230
1018	90	140	24	1.5	75 000	97 000	4 800	5 600	1.340
1019	95	145	24	1.5	77 000	102 000	4 500	5 300	1.400
1020	100	150	24	1.5	79 000	107 000	4 300	5 300	1.660
1021	105	160	26	2	93 000	127 000	4 000	4 800	1.850
1022	110	170	28	2	111 000	148 000	3 800	4 500	2.330
1024	120	180	28	2	118 000	162 000	3 400	4 300	2.560
1026	130	200	33	2	146 000	203 000	3 200	3 800	3.770
1028	140	210	33	2	149 000	213 000	3 000	3 600	4.000
1030	150	225	35	2.1	172 000	250 000	2 800	3 400	4.830





NU

NJ

NF

N

NUP

Bearing No. N NF NU NJ NUP	Boundary dimensions(mm)			r(mm)	Cr(N)	Cor(N)	Limiting Speed (min-1)		Mass (Kg)
	d	D	B				Grease	Oil	
1032	160	240	38	2.1	202 000	289 000	2 600	3 200	5.93
1034	170	260	42	2.1	244 000	353 000	2 400	2 800	7.90
1036	180	280	46	2.1	300 000	435 000	2 200	2 600	9.60
1038	190	290	46	2.1	310 000	455 000	2 000	2 600	10.80
1040	200	310	51	2.1	330 000	493 000	2 000	2 400	14.00
1044	220	340	56	3	425 000	638 000	1 800	2 300	18.50
1048	240	360	56	3	450 000	697 000	1 700	2 100	20.10
1052	260	400	65	4	550 000	850 000	1 600	1 800	28.70
1056	280	420	65	4	560 000	892 500	1 500	1 700	32.30
1060	300	460	74	4	750 000	1 190 000	1 400	1 500	43.80
1064	320	480	74	4	770 000	1 250 000	1 300	1 400	48.20
1068	340	520	82	5	920 000	1 480 000	1 200	1 300	63.10
1072	360	540	82	5	945 000	1 550 000	1 100	1 250	66.30
1076	380	560	82	5	970 000	1 620 000	1 000	1 200	71.25
1080	400	600	90	5	1 156 000	1 940 000	950	1 100	92.00
1084	420	620	90	5	1 180 000	2 020 000	900	1 100	95.40
1088	440	650	94	6	1 300 000	2 150 000	850	1 050	108.00
1092	460	680	100	6	1 380 000	2 330 000	800	1 000	127.00
1096	480	700	100	6	1 400 000	2 430 000	780	950	131.00

# Cylindrical Roller Bearings

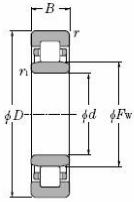

Type NU



Type NJ



Type NUP



Type N



Type NF

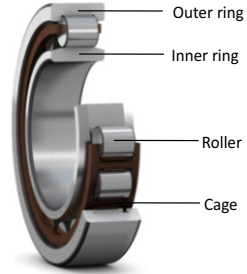

Bearing No. N NF NU NJ NUP	Boundary dimensions(mm)			r(mm)	Cr(N)	Cor(N)	Limiting Speed (min-1)		Mass (Kg)
	d	D	B				Grease	Oil	
203	17	40	12	0.6	10 800	6 700	16 000	19 000	0.120
204	20	47	14	1	13 000	10 800	15 000	18 000	0.110
205	25	52	15	1	15 000	13 400	13 000	16 000	0.130
206	30	62	16	1	20 000	18 300	11 000	13 000	0.200
207	35	72	17	1.1	28 500	26 800	9 500	11 000	0.290
208	40	80	18	1.1	37 000	36 600	8 500	10 000	0.370
209	45	85	19	1.1	39 000	40 000	7 500	9 000	0.410
210	50	90	20	1.1	40 000	43 400	7 100	8 500	0.460
211	55	100	21	1.5	49 000	52 700	6 300	7 500	0.610
212	60	110	22	1.5	58 000	63 800	6 000	7 100	0.780
213	65	120	23	1.5	72 000	80 400	5 300	6 300	0.990
214	70	125	24	1.5	72 000	80 800	5 000	6 300	1.050
215	75	130	25	1.5	82 000	94 000	4 800	6 000	1.200
216	80	140	26	2	90 000	104 000	4 500	5 300	1.400
217	85	150	28	2	102 000	119 000	4 300	5 000	1.800
218	90	160	30	2	129 000	150 000	4 000	4 800	2.150
219	95	170	32	2.1	140 000	165 000	3 800	4 500	2.600
220	100	180	34	2.1	156 000	184 000	3 600	4 300	3.150
221	105	190	36	2.1	170 000	205 000	3 400	4 000	3.700
222	110	200	38	2.1	204 000	246 500	3 200	3 800	4.350
224	120	215	40	2.1	225 000	272 000	3 000	3 400	5.150
226	130	230	40	3	229 000	289 000	2 600	3 200	5.800
228	140	250	42	3	264 000	357 000	2 400	3 000	7.450
230	150	270	45	3	319 000	416 000	2 200	2 800	9.400



NU

NJ

NF

N

NUP

Bearing No. N NF NU NJ NUP	Boundary dimensions(mm)			r(mm)	Cr(N)	Cor(N)	Limiting Speed (min-1)		Mass (Kg)
	d	D	B				Grease	Oil	
232	160	290	48	3	365 000	484 000	2 200	2 600	14.300
234	170	310	52	4	404 000	540 000	2 000	2 400	17.600
236	180	320	52	4	420 000	573 000	1 900	2 200	18.200
238	190	340	55	4	470 000	654 000	1 800	2 200	22.100
240	200	360	58	4	527 000	735 000	1 500	1 800	26.100
244	220	400	65	4	646 000	918 000	1 500	1 800	36.000
248	240	440	72	4	795 000	1 139 000	1 400	1 600	50.000
252	260	480	80	5	900 000	1 411 000	1 300	1 500	66.300
256	280	500	80	5	969 000	1 428 000	1 200	1 400	70.000
260	300	540	85	5	1 190 000	1 760 000	1 100	1 300	87.000
264	320	580	92	5	1 360 000	2 030 000	1 000	1 200	109.000

# Cylindrical Roller Bearings

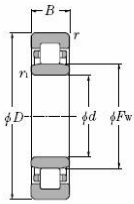

Type NU



Type NJ



Type NUP



Type N



Type NF

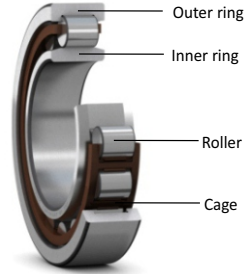

Bearing No. N NF NU NJ NUP	Boundary dimensions(mm)			r(mm)	Cr(N)	Cor(N)	Limiting Speed (min <sup>-1</sup> )		Mass (Kg)
	d	D	B				Grease	Oil	
2204	20	47	18	1	17 600	15 600	14 000	17 000	0.146
2205	25	52	18	1	20 700	19 800	12 000	14 000	0.164
2206	30	62	20	1	28 000	28 000	10 000	12 000	0.268
2207	35	72	23	1.1	41 700	43 300	8 500	10 000	0.400
2208	40	80	23	1.1	49 000	52 700	7 500	9 000	0.510
2209	45	85	23	1.1	52 300	57 800	7 400	8 900	0.550
2210	50	90	23	1.1	54 000	62 500	6 500	8 000	0.592
2211	55	100	25	1.5	64 000	74 000	6 200	7 400	0.816
2212	60	110	28	1.5	81 600	98 600	5 300	6 300	1.126
2213	65	120	31	1.5	92 000	127 000	4 800	6 000	1.492
2214	70	125	31	1.5	101 000	128 500	4 800	5 600	1.566
2215	75	130	31	1.5	110 000	138 000	4 500	5 300	1.634
2216	80	140	33	2	125 000	158 000	4 000	5 000	2.058
2217	85	150	36	2	144 000	185 000	3 800	4 500	2.574
2218	90	160	40	2	176 000	225 000	3 600	4 300	3.252
2219	95	170	43	2.1	195 000	254 000	3 400	4 000	4.100
2220	100	180	46	2.1	220 000	284 000	3 200	3 800	4.680
2222	110	200	53	2.1	272 000	374 000	2 800	3 400	6.853
2224	120	215	58	2.1	310 000	417 000	2 600	3 200	8.500
2226	130	230	64	3	323 000	450 000	2 400	3 000	11.000
2228	140	250	68	3	395 000	570 000	2 200	2 800	13.500
2230	150	270	73	3	463 000	680 000	2 000	2 600	18.400



NU

NJ

NF

N

NUP

Bearing No. N NF NU NJ NUP	Boundary dimensions(mm)			r(mm)	Cr(N)	Cor(N)	Limiting Speed (min-1)		Mass (Kg)
	d	D	B				Grease	Oil	
2232	160	290	80	3	535 000	799 000	1 800	2 200	24.000
2234	170	310	86	4	620 000	935 000	1 800	2 200	29.000
2236	180	320	86	4	660 000	1 028 000	1 700	2 000	31.600
2238	190	340	92	4	705 000	1 095 000	1 600	2 000	35.800
2240	200	360	98	4	787 000	1 225 000	1 500	1 800	44.000
2244	220	400	108	4	960 000	1 535 000	1 400	1 700	61.000
2248	240	440	120	4	1 224 000	1 972 000	1 300	1 600	82.000
2252	260	480	130	5	1 520 000	2 490 000	1 100	1 300	102.000

# Cylindrical Roller Bearings

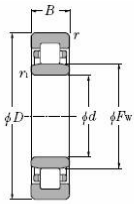

Type NU



Type NJ



Type NUP



Type N



Type NF

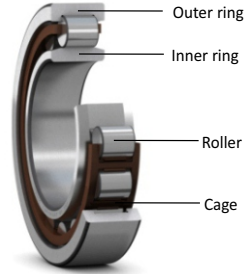

Bearing No. N NF NU NJ NUP	Boundary dimensions(mm)			r(mm)	Cr(N)	Cor(N)	Limiting Speed (min-1)		Mass (Kg)
	d	D	B				Grease	Oil	
2304	20	52	21	1.1	26 000	23 200	11 000	14 000	0.220
2305	25	62	24	1.1	36 000	34 900	9 300	11 000	0.342
2306	30	72	27	1.1	43 800	43 400	8 200	9 800	0.500
2307	35	80	31	1.5	51 500	51 000	7 200	8 600	0.682
2308	40	90	33	1.5	70 000	74 800	6 500	7 800	0.940
2309	45	100	36	1.5	84 100	88 400	6 100	7 300	1.246
2310	50	110	40	2	103 000	111 400	5 400	6 500	1.676
2311	55	120	43	2	126 000	137 800	4 800	5 600	2.116
2312	60	130	46	2.1	143 000	159 000	4 300	5 300	2.632
2313	65	140	48	2.1	160 000	180 000	4 000	4 800	3.128
2314	70	150	51	2.1	190 000	222 800	3 800	4 500	3.946
2315	75	160	55	2.1	220 000	255 000	3 400	4 300	4.700
2316	80	170	58	2.1	232 000	280 000	3 200	4 000	6.100
2317	85	180	60	3	268 000	323 000	3 000	3 800	7.050
2318	90	190	64	3	276 000	335 000	2 800	3 600	8.450
2319	95	200	67	3	315 000	391 000	2 600	3 400	9.800
2320	100	215	73	3	369 000	463 000	2 400	3 200	12.500
2322	110	240	80	3	485 000	625 000	2 200	2 800	18.800
2324	120	260	86	3	604 000	782 000	2 000	2 600	23.100
2326	130	280	93	4	714 000	960 000	1 900	2 400	29.000
2328	140	300	102	4	782 000	1 060 000	1 800	2 200	36.100
2330	150	320	108	4	867 000	1 190 000	1 700	2 000	44.300
2332	160	340	114	4	909 000	1 290 000	1 500	1 900	52.150
2334	170	360	120	4	1 037 000	1 480 000	1 400	1 800	62.400
2336	180	380	126	4	1 173 000	1 690 000	1 300	1 700	73.000
2338	190	400	132	5	1 220 000	1 888 000	1 300	1 600	85.000
2340	200	420	138	5	1 280 000	1 900 000	1 200	1 500	96.100



NU

NJ

NF

N

NUP

Bearing No. N NF NU NJ NUP	Boundary dimensions(mm)			r(mm)	Cr(N)	Cor(N)	Limiting Speed (min-1)		Mass (Kg)
	d	D	B				Grease	Oil	
304	20	52	15	1.1	18 200	14 800	12 000	15 000	0.140
305	25	62	17	1.1	25 000	21 400	10 000	13 000	0.230
306	30	72	19	1.1	32 800	29 800	8 500	11 000	0.350
307	35	80	21	1.5	42 000	40 000	8 000	9 500	0.460
308	40	90	23	1.5	49 000	48 500	6 700	8 000	0.630
309	45	100	25	1.5	66 700	65 900	6 300	7 500	0.830
310	50	110	27	2	74 000	73 000	5 600	6 700	1.050
311	55	120	29	2	93 500	94 500	5 000	6 300	1.350
312	60	130	31	2.1	105 000	107 000	4 800	5 600	1.700
313	65	140	33	2.1	115 000	118 000	4 500	5 300	2.100
314	70	150	35	2.1	135 000	165 000	4 000	5 000	2.500
315	75	160	37	2.1	155 000	175 000	3 800	4 800	3.000
316	80	170	39	2.1	161 500	180 000	3 600	4 300	3.600
317	85	180	41	3	190 000	210 000	3 400	4 000	4.250
318	90	190	43	3	204 000	225 000	3 200	3 800	4.900
319	95	200	45	3	220 000	245 000	3 000	3 600	5.650
320	100	215	47	3	255 000	284 000	2 800	3 400	7.000
321	105	225	49	3	289 000	328 000	2 600	3 200	8.250
322	110	240	50	3	323 000	369 000	2 600	3 000	9.550
324	120	260	55	3	382 500	433 000	2 200	2 800	14.500
326	130	280	58	4	472 000	565 000	2 200	2 600	18.000
328	140	300	62	4	505 000	633 000	2 000	2 400	22.000
330	150	320	65	4	561 000	684 000	1 800	2 200	26.000
332	160	340	68	4	595 000	743 000	1 700	2 000	31.200
334	170	360	72	4	675 000	850 000	1 600	2 000	37.100
336	180	380	75	4	770 000	977 000	1 500	1 800	42.700
338	190	400	78	5	810 000	1 050 000	1 400	1 700	49.400
340	200	420	80	5	850 000	1 090 000	1 300	1 700	55.600
344	220	460	88	5	1 020 000	1 334 000	1 200	1 500	73.600
348	240	500	95	5	1 215 000	1 658 000	1 100	1 300	93.000
352	260	540	102	6	1 377 000	1 890 000	1 000	1 200	117.000

# Cylindrical Roller Bearings

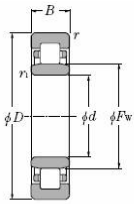

Type NU



Type NJ



Type NUP



Type N



Type NF

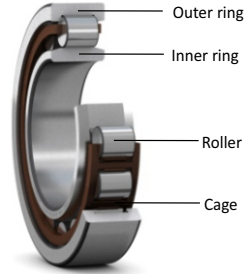

Bearing No. N NF NU NJ NUP	Boundary dimensions(mm)			r(mm)	Cr(N)	Cor(N)	Limiting Speed (min <sup>-1</sup> )		Mass (Kg)
	d	D	B				Grease	Oil	
405	25	80	21	1.5	40 000	34 000	7 500	9 000	0.530
406	30	90	23	1.5	53 000	46 800	7 500	9 500	0.740
407	35	100	25	1.5	63 000	58 700	6 700	8 000	0.950
408	40	110	27	2	81 000	75 700	6 000	7 500	1.250
409	45	120	29	2	91 000	86 700	5 600	6 700	1.550
410	50	130	31	2.1	117 000	115 600	5 000	6 000	1.900
411	55	140	33	2.1	119 000	117 300	4 800	5 600	2.300
412	60	150	35	2.1	142 000	142 800	4 300	5 300	2.750
413	65	160	37	2.1	166 000	172 000	4 000	4 800	3.300
414	70	180	42	3	194 000	200 000	3 600	4 300	4.850
415	75	190	45	3	223 000	232 000	3 400	4 000	6.800
416	80	200	48	3	254 000	267 000	3 200	3 800	8.000
417	85	210	52	4	280 000	297 000	3 000	3 800	9.100
418	90	225	54	4	318 000	340 000	2 800	3 400	10.600
419	95	240	55	4	340 000	378 000	2 600	3 200	13.000
420	100	250	58	4	382 500	425 000	2 600	3 000	14.300
421	105	260	60	4	420 000	471 000	2 400	3 000	15.700
422	110	280	65	4	467 500	527 000	2 200	2 800	20.500
424	120	310	72	5	574 000	654 500	2 000	2 400	28.700
426	130	340	78	5	700 000	811 000	1 800	2 200	36.400
428	140	360	82	5	743 000	867 000	1 700	2 000	48.000
430	150	380	85	5	790 000	952 000	1 600	2 000	54.100





NU



NJ



NF



N



NUP

## Cylindrical Roller Bearings

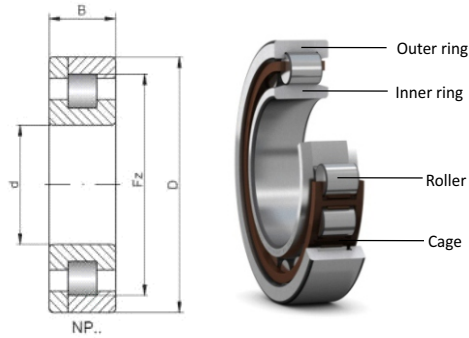

Bearing No.	Boundary dimensions(mm)			r(mm)	Cr(N)	Cor(N)	Limiting Speed (min-1)		Mass (Kg)
	d	D	B				Grease	Oil	
NP 203	17	40	12	0.6	10 700	6 800	16 000	19 000	0.120
NP 204	20	47	14	1	13 000	10 800	15 000	18 000	0.110
NP 205	25	52	15	1	15 000	13 400	13 000	16 000	0.130
NP 206	30	62	16	1	20 000	18 300	11 000	13 000	0.200
NP 207	35	72	17	1.1	28 500	26 800	9 500	11 000	0.290
NP 208	40	80	18	1.1	37 000	36 600	8 500	10 000	0.370
NP 209	45	85	19	1.1	39 100	40 000	7 500	9 000	0.410
NP 210	50	90	20	1.1	40 800	43 400	7 100	8 500	0.460
NP 211	55	100	21	1.5	49 300	52 700	6 300	7 500	0.610
NP 212	60	110	22	1.5	58 300	63 800	6 000	7 100	0.780
NP 213	65	120	23	1.5	65 000	80 400	5 300	6 300	0.990
NP 214	70	125	24	1.5	71 000	80 800	5 000	6 300	1.050
NP 215	75	130	25	1.5	82 000	94 400	4 800	6 000	1.200
NP 216	80	140	26	2	90 000	103 000	4 500	5 300	1.400
NP 217	85	150	28	2	102 000	119 000	4 300	5 000	1.800
NP 218	90	160	30	2	129 200	151 000	4 000	4 800	2.150
NP 219	95	170	32	2.1	140 000	165 000	3 800	4 500	2.600
NP 220	100	180	34	2.1	155 000	184 000	3 600	4 300	3.150



Bearing No.	Boundary dimensions(mm)			r(mm)	Cr(N)	Cor(N)	Limiting Speed (min-1)		Mass (Kg)
	d	D	B				Grease	Oil	
NP 221	105	190	36	2.1	171 700	204 000	3 400	4 000	3.700
NP 222	110	200	38	2.1	204 000	246 500	3 200	3 800	4.350
NP 224	120	215	40	2.1	221 000	272 000	3 000	3 400	5.150
NP 226	130	230	40	3	229 500	289 000	2 600	3 200	5.800
NP 228	140	250	42	3	263 500	357 000	2 400	3 000	7.450
NP 230	150	270	45	3	318 000	416 500	2 200	2 800	9.400
NP 232	160	290	48	3	365 500	484 500	2 200	2 600	14.300
NP 234	170	310	52	4	404 000	540 000	2 000	2 400	17.600
NP 236	180	320	52	4	420 000	574 000	1 900	2 200	18.200
NP 238	190	340	55	4	472 000	655 000	1 800	2 200	22.100
NP 240	200	360	58	4	527 000	735 000	1 500	1 800	26.100
NP 244	220	400	65	4	646 000	918 000	1 500	1 800	36.000
NP 248	240	440	72	4	795 000	1 139 000	1 400	1 600	50.000
NP 252	260	480	80	5	850 000	1 411 000	1 300	1 500	66.300
NP 256	280	500	80	5	969 000	1 428 000	1 200	1 400	70.000
NP 260	300	540	85	5	1 190 000	1 759 000	1 100	1 300	87.000
NP 264	320	580	92	5	1 360 000	2 030 000	1 000	1 200	109.000

# Cylindrical Roller Bearings

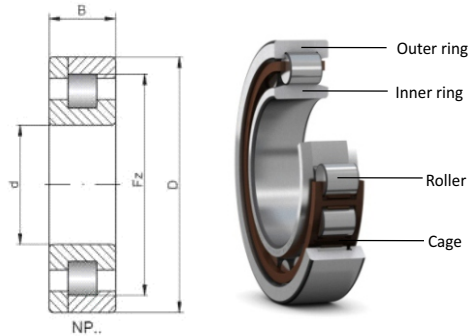

Bearing No.	Boundary dimensions(mm)			r(mm)	Cr(N)	Cor(N)	Limiting Speed (min-1)		Mass (Kg)
	d	D	B				Grease	Oil	
NP 304	20	52	15	1.1	18 200	14 700	12 000	15 000	0.140
NP 305	25	62	17	1.1	25 000	21 400	10 000	13 000	0.230
NP 306	30	72	19	1.1	32 800	29 800	8 500	11 000	0.350
NP 307	35	80	21	1.5	42 000	40 000	8 000	9 500	0.460
NP 308	40	90	23	1.5	49 800	48 500	6 700	8 000	0.630
NP 309	45	100	25	1.5	66 800	65 800	6 300	7 500	0.830
NP 310	50	110	27	2	74 000	73 100	5 600	6 700	1.050
NP 311	55	120	29	2	93 500	94 400	5 000	6 300	1.350
NP 312	60	130	31	2.1	105 400	108 000	4 800	5 600	1.700
NP 313	65	140	33	2.1	115 000	118 000	4 500	5 300	2.100
NP 314	70	150	35	2.1	135 000	165 000	4 000	5 000	2.500
NP 315	75	160	37	2.1	150 000	172 000	3 800	4 800	3.000
NP 316	80	170	39	2.1	161 500	177 000	3 600	4 300	3.600
NP 317	85	180	41	3	190 000	209 000	3 400	4 000	4.250
NP 318	90	190	43	3	204 000	225 000	3 200	3 800	4.900
NP 319	95	200	45	3	220 000	245 000	3 000	3 600	5.650
NP 320	100	215	47	3	255 000	284 000	2 800	3 400	7.000
NP 321	105	225	49	3	289 000	327 000	2 600	3 200	8.250
NP 322	110	240	50	3	323 000	369 000	2 600	3 000	9.550
NP 324	120	260	55	3	382 500	433 000	2 200	2 800	14.500
NP 326	130	280	58	4	472 000	565 000	2 200	2 600	18.000
NP 328	140	300	62	4	506 000	633 000	2 000	2 400	22.000
NP 330	150	320	65	4	561 000	685 000	1 800	2 200	26.000
NP 332	160	340	68	4	595 000	744 000	1 700	2 000	31.200
NP 334	170	360	72	4	676 000	858 000	1 600	2 000	37.100
NP 336	180	380	75	4	770 000	977 000	1 500	1 800	42.700
NP 338	190	400	78	5	830 000	1 050 000	1 400	1 700	49.400
NP 340	200	420	80	5	850 000	1 080 000	1 300	1 700	55.600
NP 344	220	460	88	5	1 020 000	1 334 000	1 200	1 500	73.600
NP 348	240	500	95	5	1 210 000	1 655 000	1 100	1 300	93.000
NP 352	260	540	102	6	1 370 000	1 880 000	1 000	1 200	117.000



Bearing No.	Boundary dimensions(mm)			r(mm)	Cr(N)	Cor(N)	Limiting Speed (min-1)		Mass (Kg)
	d	D	B				Grease	Oil	
NP 405	25	80	21	1.5	39 500	34 000	7 500	9 000	0.530
NP 406	30	90	23	1.5	53 000	46 800	7 500	9 500	0.740
NP 407	35	100	25	1.5	64 000	58 600	6 700	8 000	0.950
NP 408	40	110	27	2	81 000	75 700	6 000	7 500	1.250
NP 409	45	120	29	2	91 000	86 700	5 600	6 700	1.550
NP 410	50	130	31	2.1	117 000	115 600	5 000	6 000	1.900
NP 411	55	140	33	2.1	119 000	117 300	4 800	5 600	2.300
NP 412	60	150	35	2.1	142 000	142 800	4 300	5 300	2.750
NP 413	65	160	37	2.1	166 000	173 000	4 000	4 800	3.300
NP 414	70	180	42	3	194 000	200 000	3 600	4 300	4.850
NP 415	75	190	45	3	222 000	233 000	3 400	4 000	6.800
NP 416	80	200	48	3	254 000	267 000	3 200	3 800	8.000
NP 417	85	210	52	4	280 000	297 500	3 000	3 800	9.100
NP 418	90	225	54	4	320 000	340 000	2 800	3 400	10.600
NP 419	95	240	55	4	340 000	378 000	2 600	3 200	13.000
NP 420	100	250	58	4	382 500	425 000	2 600	3 000	14.300
NP 421	105	260	60	4	420 000	471 000	2 400	3 000	15.700
NP 422	110	280	65	4	467 500	527 000	2 200	2 800	20.500
NP 424	120	310	72	5	574 000	654 000	2 000	2 400	28.700
NP 426	130	340	78	5	702 000	811 000	1 800	2 200	36.400
NP 428	140	360	82	5	744 000	867 000	1 700	2 000	48.000
NP 430	150	380	85	5	790 000	952 000	1 600	2 000	54.100

# Cylindrical Roller Bearings

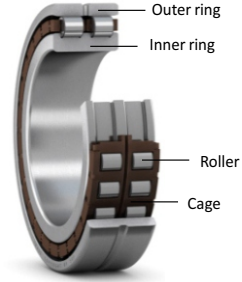
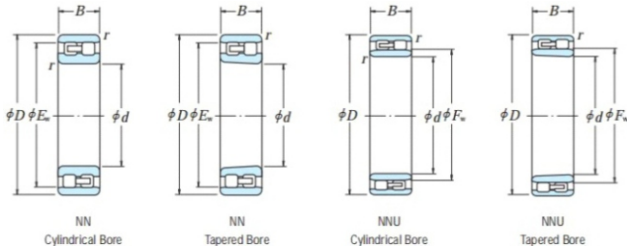

Bearing No.	Boundary dimensions(mm)			r(mm)	Cr(N)	Cor(N)	Limiting Speed (min-1)		Mass (Kg)
	d	D	B				Grease	Oil	
NN 3005	25	47	16	0.6	22 000	25 500	15 000	17 000	0.169
NN 3006	30	55	19	1	26 400	31 500	12 000	15 000	0.187
NN 3007	35	62	20	1	33 500	42 500	11 000	13 000	0.246
NN 3008	40	68	21	1	37 000	47 200	9 800	11 000	0.298
NN 3009	45	75	23	1	44 200	58 300	8 800	10 000	0.382
NN 3010	50	80	23	1	45 000	61 700	8 200	9 600	0.415
NN 3011	55	90	26	1.1	59 000	82 000	7 300	8 600	0.618
NN 3012	60	95	26	1.1	62 500	90 100	6 800	8 000	0.664
NN 3013	65	100	26	1.1	66 000	98 600	6 400	7 600	0.705
NN 3014	70	110	30	1.1	83 000	125 800	5 700	6 800	1.020
NN 3015	75	115	30	1.1	88 000	126 700	5 500	6 400	1.080
NN 3016	80	125	34	1.1	102 000	158 000	5 000	6 000	1.470
NN 3017	85	130	34	1.1	106 000	170 000	4 800	5 600	1.580
NN 3018	90	140	37	1.5	122 000	194 000	4 500	5 200	2.010
NN 3019	95	145	37	1.5	130 000	209 000	4 300	5 000	2.100
NN 3020	100	150	37	1.5	135 000	225 000	4 000	4 800	2.210
NN 3021	105	160	41	2	168 500	272 000	3 800	4 500	2.820
NN 3022	110	170	45	2	195 000	318 000	3 600	4 300	3.560
NN 3024	120	180	46	2	204 000	344 000	3 300	3 900	3.870
NN 3026	130	200	52	2	242 000	403 000	3 000	3 600	5.760
NN 3028	140	210	53	2	254 000	438 000	2 800	3 400	6.410
NN 3030	150	225	56	2.1	285 000	497 000	2 600	3 100	7.500
NN 3032	160	240	60	2.1	320 000	561 000	2 500	2 900	9.080
NN 3034	170	260	67	2.1	385 000	684 000	2 300	2 700	12.450
NN 3036	180	280	74	2.1	480 000	845 000	2 100	2 500	16.280
NN 3038	190	290	75	2.1	505 000	918 000	2 000	2 400	17.250
NN 3040	200	310	82	2.1	560 000	995 000	1 900	2 200	21.240
NN 3044	220	340	90	3	693 000	1 258 000	1 700	2 000	27.500
NN 3048	240	360	92	3	727 000	1 360 000	1 600	1 900	30.000
NN 3052	260	400	104	4	880 000	1 760 000	1 400	1 700	42.000
NN 3056	280	420	106	4	918 000	1 768 000	1 300	1 600	46.500
NN 3060	300	460	118	4	1 200 000	2 330 000	1 200	1 400	62.000
NN 3064	320	480	121	4	1 230 000	2 340 000	1 200	1 400	70.000



Bearing No.	Boundary dimensions(mm)			r(mm)	Cr(N)	Cor(N)	Limiting Speed (min-1)		Mass (Kg)
	d	D	B				Grease	Oil	
NNU 4920	100	140	40	1.1	132 000	260 000	4 200	5 000	1.840
NNU 4921	105	145	40	1.1	136 000	276 000	4 000	4 800	1.870
NNU 4922	110	150	40	1.1	142 000	284 000	3 900	4 600	1.960
NNU 4924	120	165	45	1.1	155 000	306 000	3 500	4 200	2.740
NNU 4926	130	180	50	1.5	233 000	480 000	3 200	3 800	3.830
NNU 4928	140	190	50	1.5	240 000	497 000	3 000	3 600	4.570
NNU 4930	150	210	60	2	297 000	607 000	2 700	3 300	6.100
NNU 4932	160	220	60	2	310 000	646 000	2 600	3 100	6.460
NNU 4934	170	230	60	2	318 000	685 000	2 400	2 900	7.600
NNU 4936	180	250	69	2	408 000	867 000	2 200	2 700	10.800
NNU 4938	190	260	69	2	412 000	900 000	2 100	2 600	11.700
NNU 4940	200	280	80	2.1	484 500	1 037 000	2 000	2 400	14.500
NNU 4944	220	300	80	2.1	510 000	1 130 000	1 800	2 200	16.600
NNU 4948	240	320	80	2.1	530 000	1 235 000	1 700	2 000	17.500
NNU 4952	260	360	100	2.1	794 000	1 785 000	1 500	1 800	28.500
NNU 4956	280	380	100	2.1	816 000	1 895 000	1 400	1 700	32.000
NNU 4960	300	420	118	3	1 045 000	2 448 000	1 300	1 500	46.000
NNU 4964	320	440	118	3	1 080 000	2 595 000	1 200	1 400	50.000





**ASB<sup>®</sup>** | 



**Needle  
Roller  
Bearings** | 

## Needle Roller Bearings Cages Assemblies

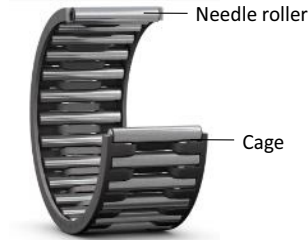
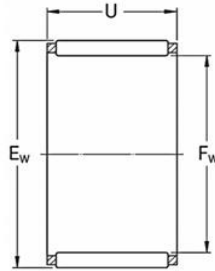

Bearing No.	Boundary dimensions(mm)			Cr(N)	Cor(N)	Limiting Speed (min-1)		Mass (Kg)
	F	D	C			Grease	Oil	
KT 6X9X10	6	9	10	3 300	3 100	-	30 000	0.003
KT 9X12X10	9	12	10	4 200	4 700	-	30 000	0.003
KT 9X13X13.6	9	13	13.6	5 000	5 500	-	30 000	0.005
KT 10X14X10	10	14	10	7 000	7 900	-	28 000	0.002
KT 10X14X12.5	10	14	12.5	8 000	9 100	-	28 000	0.004
KT 10X14X14.5	10	14	14.5	8 500	9 500	-	28 000	0.004
KT 10.5X14X13.8	10.5	14	13.8	7 000	9 300	-	28 000	0.004
KT 11X15X12	11	15	12	4 200	5 500	-	24 000	0.004
KT 12X15X13	12	15	13	6 000	8 100	-	24 000	0.004
KT 12X15X14.3	12	15	14.3	7 000	9 000	-	24 000	0.004
KT 12X15X16.6	12	15	16.6	4 200	4 700	-	24 000	0.006
KT 12X16X10	12	16	10	6 000	6 900	-	24 000	0.004
KT 12X16X13	12	16	13	7 900	9 200	-	24 000	0.005
KT 12X16X16	12	16	16	9 300	10 000	-	24 000	0.006
KT 12X16X24 ZW	12	16	24	9 800	8 000	-	24 000	0.010
KT 14X18X16	14	18	16	9 200	12 000	-	22 000	0.008
KT 14X18X16.5	14	18	16.5	10 000	13 000	-	22 000	0.008
KT 14X18X17	14	18	17	10 500	13 900	-	22 000	0.014
KT 14X18X20	14	18	20	9 900	10 500	-	22 000	0.014
KT 14X19X10	14	19	10	7 000	8 500	-	22 000	0.006
KT 15X18X22 ZW	15	18	22	9 600	15 900	-	22 000	0.008
KT 15X19X19.5	15	19	19.5	12 800	20 100	-	22 000	0.010
KT 15X21X10	15	21	10	11 000	125 000	-	22 000	0.009
KT 16X20X17	16	20	17	10 000	15 000	-	20 000	0.008
KT 16X20X20	16	20	20	13 000	20 000	-	20 000	0.008
KT 16X20X23.8	16	20	23.8	15 000	22 000	-	20 000	0.012
KT 16X21X10	16	21	10	9 000	12 000	-	20 000	0.006
KT 16X22X9.6	16	22	9.6	10 000	110 000	-	20 000	0.007
KT 16X22X12	16	22	12	11 000	12 000	-	20 000	0.010
KT 16X22X13	16	22	13	12 000	13 400	-	20 000	0.009
KT 16X23X13.8	16	23	13.8	14 300	17 000	-	20 000	0.014



Single Row Cages



Double Row Cages

Bearing No.	Boundary dimensions(mm)			Cr(N)	Cor(N)	Limiting Speed (min-1)		Mass (Kg)
	F	D	C			Grease	Oil	
KT 17X22X22	17	22	22	12 000	17 400	-	20 000	0.016
KT 17X23X32 ZW	17	23	32	13 000	19 000	-	20 000	0.032
KT 17.5X22X15.8	17.5	22	15.8	11 000	15 000	-	20 000	0.010
KT 18X22X22	18	22	22	15 000	18 000	-	20 000	0.012
KT 18X24X12	18	24	12	11 200	12 900	-	20 000	0.011
KT 18X24X17	18	24	17	12 000	15 000	-	20 000	0.016
KT 18X24X20	18	24	20	20 000	26 500	-	20 000	0.019
KT 19X25X15	19	25	15	13 000	16 000	-	18 000	0.023
KT 19X25X32	19	25	32	13 000	19 000	-	18 000	0.030
KT 19X28X13.8	19	28	13.8	14 500	22 000	-	18 000	0.030
KT 20X24X26.6 ZW	20	24	26.6	20 500	27 000	-	18 000	0.025
KT 20X26X11.8	20	26	11.8	14 000	19 000	-	18 000	0.013
KT 20X26X14	20	26	14	15 000	17 000	-	18 000	0.015
KT 20X26X16	20	26	16	18 000	25 000	-	18 000	0.017
KT 20X26X17	20	26	17	18 700	25 500	-	18 000	0.017
KT 20X26X20	20	26	20	20 600	28 500	-	18 000	0.020
KT 20X27X14	20	27	14	13 000	18 000	-	18 000	0.018
KT 20X28X20	20	28	20	18 000	21 000	-	18 000	0.029
KT 20X30X20	20	30	20	15 000	19 000	-	18 000	0.037
KT 22X26X17	22	26	17	16 000	20 000	-	16 000	0.012
KT 22X28X14	22	28	14	14 000	19 000	-	16 000	0.020
KT 22X28X15	22	28	15	14 000	19 000	-	16 000	0.022
KT 22X28X16	22	28	16	15 000	20 000	-	16 000	0.024
KT 22X28X13.8 (AG)	22	28	13.8	18 000	20 000	-	16 000	0.020
KT 22X28X15.8 (AG)	22	28	15.8	19 000	26 500	-	16 000	0.022
KT 22X28X17.8 (AG)	22	28	17.8	20 000	27 000	-	16 000	0.025
KT 22X28X23	22	28	23	21 000	28 000	-	16 000	0.025
KT 22X29X14	22	29	14	19 500	22 000	-	16 000	0.022
KT 22X29X15	22	29	15	19 600	22 000	-	16 000	0.024
KT 22X29X17.8 (AG)	22	29	17.8	20 000	23 000	-	16 000	0.026
KT 22X30X15	22	30	15	19 600	22 900	-	16 000	0.027
KT 22X30X24	22	30	24	22 000	26 000	-	16 000	0.037

## Needle Roller Bearings Cages Assemblies

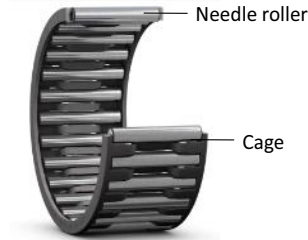
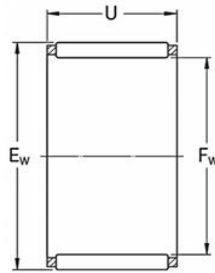

Bearing No.	Boundary dimensions(mm)			Cr(N)	Cor(N)	Limiting Speed (min-1)		Mass (Kg)
	F	D	C			Grease	Oil	
KT 22X32X15.8	22	32	15.8	20 000	23 400	-	16 000	0.045
KT 22X36X17	22	36	17	24 000	29 000	-	16 000	0.052
KT 23X33X20	23	33	20	20 000	28 000	-	16 000	0.040
KT 23.3X32.3X15.8	23.3	32.3	15.8	20 000	26 000	-	16 000	0.032
KT 25X30X20	25	30	20	21 100	28 000	-	14 000	0.022
KT 25X30X25	25	30	25	21 700	40 400	-	14 000	0.025
KT 25X32X16	25	32	16	20 500	27 500	-	14 000	0.027
KT 25X33X24	25	33	24	33 900	46 500	-	14 000	0.046
KT 25X33X30	25	33	30	35 000	48 000	-	14 000	0.040
KT 25X33X32	25	33	32	35 000	48 000	-	14 000	0.054
KT 25X34X18	25	34	18	48 000	67 000	-	14 000	0.025
KT 25X35X18	25	35	18	46 500	61 500	-	14 000	0.027
KT 25X35X24.3	25	35	24.3	47 000	63 000	-	14 000	0.380
KT 26X33X34	26	33	34	48 000	65 000	-	14 000	0.053
KT 28X33X21	28	33	21	20 000	25 000	-	14 000	0.022
KT 28X33X27	28	33	27	22 800	33 000	-	14 000	0.032
KT 28X35X32.5	28	35	32.5	34 500	34 000	-	14 000	0.052
KT 28X35X44.5 ZW	28	35	44.5	38 000	42 000	-	14 000	0.074
KT 28X36X45.8 ZW	28	36	45.8	40 000	58 000	-	14 000	0.086
KT 28X38X17	28	40	25	32 000	36 000	-	14 000	0.039
KT 30X34X34	30	34	34	13 000	19 000	-	12 000	0.032
KT 30X35X27	30	35	27	28 500	52 000	-	12 000	0.033
KT 30X37X16	30	37	16	22 500	58 500	-	12 000	0.026
KT 30X37X20	30	37	20	23 000	59 000	-	12 000	0.030
KT 30X40X20	30	40	20	31 500	39 000	-	12 000	0.056
KT 30X42X15	30	42	15	30 000	34 000	-	12 000	0.048
KT 30X42X22	30	42	22	33 000	42 000	-	12 000	0.078
KT 30X42X30	30	42	30	34 000	43 500	-	12 000	0.101
KT 30X43X54.8 ZW	30	43	54.8	45 000	63 000	-	12 000	0.195
KT 31X43X15	31	43	15	32 000	36 000	-	12 000	0.105
KT 31X44X43	31	44	43	46 000	64 000	-	12 000	0.147



Single Row



Double Row

Bearing No.	Boundary dimensions(mm)			Cr(N)	Cor(N)	Limiting Speed (min-1)		Mass (Kg)
	F	D	C			Grease	Oil	
KT 32X37X24.5	32	37	27	26 000	48 000	-	12 000	0.034
KT 32X37X28 ZW	32	37	28	23 100	43 000	-	12 000	0.042
KT 32X37X29.5	32	37	29.5	29 000	48 000	-	12 000	0.045
KT 32X37X35.8	32	37	35.8	32 000	50 000	-	12 000	0.045
KT 32X42X50	32	42	50	53 000	83 500	-	12 000	0.130
KT 32X46X18	32	46	18	35 000	42 000	-	12 000	0.055
KT 34X42X38	34	42	38	45 000	72 000	-	10 000	0.085
KT 34X44X40	34	44	40	47 000	75 000	-	10 000	0.110
KT 34.93X42.86X17.46	34.93	42.86	17.46	28 000	42 000	-	10 000	0.039
KT 34.93X42.86X31.75	34.93	42.86	31.75	42 000	70 000	-	10 000	0.076
KT 35X39X38 ZW	35	39	38	32 000	55 000	-	10 000	0.043
KT 35X40X27	35	40	27	24 500	48 000	-	10 000	0.036
KT 35X40X30	35	40	30	25 000	49 500	-	10 000	0.041
KT 35X40X33	35	40	33	35 000	70 000	-	10 000	0.044
KT 35X41X14	35	41	14	18 000	27 000	-	10 000	0.028
KT 35X45X28.7	35	45	28.7	27 000	49 000	-	10 000	0.098
KT 35X45X40	35	45	40	50 000	63 000	-	10 000	0.127
KT 35X51X30	35	51	30	55 000	68 000	-	10 000	0.157
KT 36X41X30	36	41	30	23 000	43 000	-	10 000	0.049
KT 36X52X30	36	52	30	42 000	62 000	-	10 000	0.163
KT 37X42X17	37	42	17	21 900	42 500	-	10 000	0.026
KT 37X42X30	37	42	30	31 500	67 500	-	10 000	0.045
KT 37X42X31.5	37	42	31.5	35 000	69 000	-	10 000	0.048
KT 37X43X36.5	37	43	36.5	60 000	95 000	-	10 000	0.064
KT 38X44X33	38	44	33	45 000	68 000	-	10 000	0.061
KT 38X44X43 ZW	38	44	43	50 000	75 000	-	10 000	0.059
KT 38X46X20	38	46	20	35 000	56 500	-	10 000	0.056
KT 38X54X25	38	54	25	55 000	75 000	-	10 000	0.136
KT 38X54X30	38	54	30	57 000	80 000	-	10 000	0.153
KT 39X44X43	39	44	43	55 000	90 000	-	10 000	0.076
KT 39X54X30	39	54	30	63 000	96 000	-	10 000	0.153
KT 39X55X25	39	55	25	58 000	80 000	-	10 000	0.132

## Needle Roller Bearings Cages Assemblies

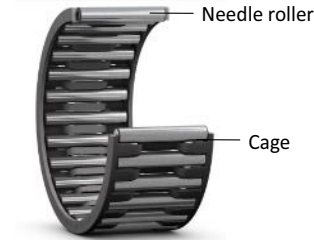
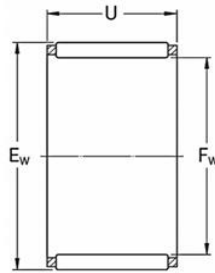

Bearing No.	Boundary dimensions(mm)			Cr(N)	Cor(N)	Limiting Speed (min-1)		Mass (Kg)
	F	D	C			Grease	Oil	
KT 40X45X26.5	40	45	26.5	32 500	72 500	-	10 000	0.044
KT 40X45X30	40	45	30	26 000	53 500	-	10 000	0.052
KT 40X45X37	40	45	37	35 000	65 000	-	10 000	0.055
KT 40X55X30	40	55	30	50 000	75 000	-	10 000	0.137
KT 40X56X22	40	56	22	42 000	53 500	-	10 000	0.138
KT 40X57X31.5	40	57	31.5	60 000	84 000	-	10 000	0.170
KT 43X48X23	43	48	23	30 000	43 500	-	9 000	0.036
KT 43X48X29.8	43	48	29.8	35 000	52 300	-	9 000	0.050
KT 43X48X33	43	48	33	39 500	58 700	-	9 000	0.050
KT 43X49X31	43	49	31	42 500	74 200	-	9 000	0.066
KT 43X50X18	43	50	18	30 500	53 500	-	9 000	0.056
KT 44X50X37	44	50	37	53 000	87 500	-	9 000	0.076
KT 44X50X39	44	50	39	60 000	98 700	-	9 000	0.081
KT 44X51X33.5	44	51	33.5	65 000	102 000	-	9 000	0.064
KT 44X64X29.5	44	64	29.5	78 000	120 000	-	9 000	0.252
KT 45X53X27.8	45	53	27.8	43 000	77 000	-	9 000	0.084
KT 45X65X43	45	65	43	68 000	110 000	-	9 000	0.345
KT 46X52X37	46	52	37	55 000	97 500	-	8 000	0.072
KT 47X53X29	47	53	25	38 000	81 500	-	8 000	0.058
KT 48X53X23	48	53	23	28 000	57 400	-	8 000	0.040
KT 48X53X28	48	53	28	32 000	67 400	-	8 000	0.051
KT 48X54X28	48	54	28	34 000	69 500	-	8 000	0.068
KT 48X54X29	48	54	29	36 500	74 500	-	8 000	0.070
KT 48X54X39	48	54	39	45 000	87 400	-	8 000	0.096
KT 49X52.7X28.5	49	52.7	28.5	36 500	72 500	-	8 000	0.048
KT 49X56X44.5	49	56	44.5	48 600	90 000	-	8 000	0.093
KT 50X55X38 ZW	50	55	38	51 700	97 500	-	7 000	0.070
KT 52X72X32	52	72	32	60 000	99 000	-	7 000	0.254
KT 54X60X30.5	54	60	30.5	39 000	95 000	-	7 000	0.089
KT 54X60X36	54	60	36	40 000	102 000	-	7 000	0.090
KT 54X61X41.1	54	61	41.1	48 000	85 000	-	7 000	0.098



Single Row



Double Row

Bearing No.	Boundary dimensions(mm)			Cr(N)	Cor(N)	Limiting Speed (min-1)		Mass (Kg)
	F	D	C			Grease	Oil	
KT 55X60X20.8	55	60	20.8	46 000	75 000	-	6 000	0.046
KT 55X60X24.1	55	60	24.1	45 800	78 500	-	6 000	0.047
KT 55X60X37	55	60	37	58 000	100 000	-	6 000	0.070
KT 55X61X16.8	55	61	16.8	30 000	63 500	-	6 000	0.043
KT 55X62X32.8	55	62	32.8	35 000	68 000	-	6 000	0.108
KT 58X65X38	58	65	38	65 000	114 000	-	6 000	0.116
KT 60X65X30	60	65	30	53 500	104 000	-	6 000	0.085
KT 60X65X41	60	65	41	56 000	109 000	-	6 000	0.093
KT 60X66X30	60	66	30	52 000	101 000	-	6 000	0.091
KT 61X66X20	61	66	20	32 000	69 500	-	5 000	0.059
KT 61X66X23	61	66	23	35 000	76 400	-	5 000	0.059
KT 65X70X20	65	70	20	30 000	76 500	-	5 000	0.057
KT 68X74X20	68	74	20	35 000	83 500	-	5 000	0.071
KT 68X75X27.5	68	75	27.5	44 000	81 200	-	5 000	0.093
KT 68X76X26.8	68	76	26.8	45 500	85 400	-	5 000	0.093
KT 68X76X35	68	76	35	50 000	93 500	-	5 000	0.143
KT 68X76X36	68	76	36	52 000	95 600	-	5 000	0.164
KT 68X76X39	68	76	39	56 000	101 000	-	5 000	0.168
KT 68X76X42.5 ZW	68	76	42.5	60 000	109 000	-	5 000	0.184
KT 68X76X48 ZW	68	76	48	62 500	114 800	-	5 000	0.207
KT 73X79X20	73	79	20	36 500	99 500	-	4 000	0.073
KT 75X81X20	75	81	20	37 000	93 500	-	4 000	0.075
KT 75X81X29.8	75	81	29.8	40 000	96 300	-	4 000	0.113
KT 75X83X30	75	83	30	61 500	142 000	-	4 000	0.147
KT 76X83X23.3	76	83	23.3	50 500	109 000	-	4 000	0.102
KT 76X83X27	76	83	27	53 500	113 000	-	4 000	0.130

## Needle Roller Bearings



Bearing No.	Boundary dimensions(mm)			Cr(N)	Cor(N)	Limiting Speed (min-1)		Mass (Kg)
	F	D	C			Grease	Oil	
KT 78X85X23.3	78	85	23.3	49 600	107 000	-	4 000	0.095
KT 85X92X18.8	85	92	18.8	46 500	110 000	-	4 000	0.090
KT 85X92X20	85	92	20	47 500	115 000	-	4 000	0.096
KT 85X92X27	85	92	27	55 000	125 000	-	4 000	0.140
KT 85X93X30.5	85	93	30.5	61 000	147 000	-	4 000	0.169
KT 85X93X35.8	85	93	35.8	66 000	152 500	-	4 000	0.206
KT 90X97X19.8	90	97	19.8	42 500	104 000	-	3 000	0.107
KT 90X97X24.8	90	97	24.8	53 000	111 000	-	3 000	0.114
KT 90X100X25	90	100	25	62 000	136 000	-	3 000	0.182
KT 92X 102X25.3	92	102	25.3	50 000	114 000	-	3 000	0.172
KT 95X102X20.8	95	102	20.8	42 000	117 000	-	3 000	0.115



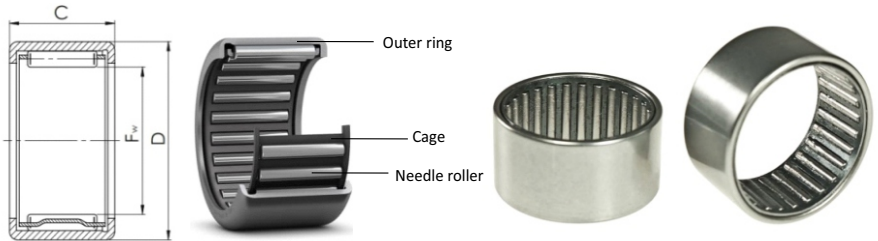

Drawn Cup Needle Roller Bearings

Bearing No.	Boundary dimensions(mm)			Cr(N)	Cor(N)	Limiting Speed (min-1)		Mass (Kg)
	F	D	C			Grease	Oil	
HK 0306	3	6.5	6	1 230	840	-	40 000	0.001
HK 0408	4	8	8	1 780	1 310	-	40 000	0.002
HK 0509	5	9	9	2 400	1 990	-	36 000	0.002
HK 0608	6	10	8	2 030	1 650	-	32 000	0.002
HK 0609	6	10	9	2 850	2 600	-	30 000	0.002
HK 0709	7	11	9	3 100	2 950	-	27 000	0.002
HK 0808	8	12	8	2 750	2 600	-	21 000	0.002
HK 0810	8	12	10	3 800	3 950	-	22 000	0.003
HK 0812	8	12	12	2 750	2 600	-	25 000	0.003
HK 0908	9	13	8	3 850	4 150	-	25 000	0.003
HK 0910	9	13	10	4 250	4 650	-	25 000	0.003
HK 0912	9	13	12	5 300	6 300	-	25 000	0.004
HK 1010	10	14	10	4 400	5 100	-	19 000	0.003
HK 1012	10	14	12	5 500	6 800	-	19 000	0.004
HK 1014	10	14	14	4 400	5 100	-	19 000	0.005
HK 1015	10	14	15	6 800	8 800	-	19 000	0.005
HK 1210	12	18	10	4 950	6 200	-	19 000	0.004
HK 1212	12	18	12	6 500	7 300	-	15 000	0.008
HK 1214	12	18	14	6 500	7 300	-	15 000	0.050
HK 1216	12	18	16	6 500	7 300	-	16 000	0.011
HK 1312	13	19	12	6 800	7 900	-	17 000	0.010
HK 1412	14	20	12	7 100	8 500	-	16 000	0.010
HK 1414	14	20	14	7 100	8 500	-	15 000	0.012
HK 1416	14	20	16	7 100	8 500	-	14 000	0.013
HK 1512	15	21	12	7 900	9 400	-	14 000	0.010
HK 1514	15	21	14	7 800	9 800	-	13 000	0.012
HK 1516	15	21	16	10 500	14 400	-	13 000	0.014
HK 1518	15	21	18	10 500	14 400	-	13 000	0.016
HK 1520	15	21	20	10 500	14 400	-	13 000	0.018

## Needle Roller Bearings

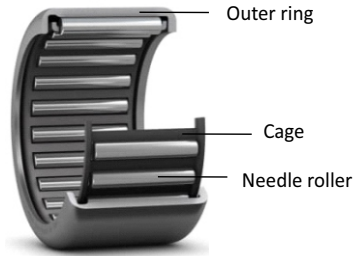
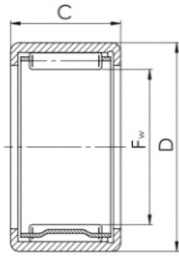

Bearing No.	Boundary dimensions(mm)			Cr(N)	Cor(N)	Limiting Speed (min-1)		Mass (Kg)
	F	D	C			Grease	Oil	
HK 1522	15	21	22	13,400	19,500	-	14000	0.020
HK 1612	16	22	12	7,600	9,700	-	14000	0.012
HK 1614	16	22	14	7,600	9,700	-	12000	0.013
HK 1616	16	22	16	10,900	15,300	-	14000	0.014
HK 1620	16	22	20	10,900	15,300	-	14000	0.020
HK 1622	16	22	22	13,100	19,400	-	14000	0.025
HK 1712	17	23	12	7,900	10,300	-	13000	0.012
HK 1812	18	24	12	8,100	10,900	-	12000	0.010
HK 1814	18	24	14	8,100	10,900	-	12000	0.012
HK 1816	18	24	16	11,600	17,300	-	12000	0.016
HK 2010	20	26	10	6,400	8,200	-	10000	0.012
HK 2012	20	26	12	8,600	12,100	-	10000	0.012
HK 2016	20	26	16	12,700	20,100	-	10000	0.016
HK 2018	20	26	18	12,700	20,100	-	10000	0.020
HK 2020	20	26	20	15,700	26,000	-	10000	0.022
HK 2030	20	26	30	21,800	40,000	-	10100	0.035
HK 2210	22	28	10	7,500	10,500	-	10100	0.012
HK 2212	22	28	12	9,100	13,400	-	10100	0.014
HK 2214	22	28	14	9,100	13,400	-	10100	0.018
HK 2216	22	28	16	13,400	22,100	-	10100	0.020
HK 2218	22	28	18	13,400	22,100	-	10100	0.022
HK 2220	22	28	20	16,500	29,000	-	10100	0.024
HK 2512	25	32	12	11,000	15,200	-	9000	0.018
HK 2516	25	32	16	15,600	24,000	-	9000	0.024
HK 2518	25	32	18	15,600	24,000	-	9000	0.030
HK 2520	25	32	20	19,900	33,000	-	9000	0.034
HK 2524	25	32	24	19,900	33,000	-	9000	0.038
HK 2526	25	32	26	25,500	45,000	-	9000	0.044
HK 2530	25	32	30	25,500	45,000	-	9000	0.055



Drawn Cup Needle Roller Bearings

Bearing No.	Boundary dimensions(mm)			Cr(N)	Cor(N)	Limiting Speed (min-1)		Mass (Kg)
	F	D	C			Grease	Oil	
HK 2538	25	32	38	34 000	66 000	-	9 000	0.065
HK 2816	28	35	16	16 400	26 500	-	8 700	0.030
HK 2820	28	35	20	20 900	36 000	-	8 700	0.038
HK 3012	30	37	12	12 100	18 200	-	8 100	0.020
HK 3016	30	37	16	17 200	29 000	-	8 100	0.030
HK 3018	30	37	18	17 200	29 000	-	8 100	0.035
HK 3020	30	37	20	22 000	39 500	-	8 100	0.040
HK 3024	30	37	24	22 000	39 500	-	8 100	0.045
HK 3026	30	37	26	28 000	54 000	-	8 100	0.050
HK 3038	30	37	38	37 500	79 000	-	8 100	0.076
HK 3512	35	42	12	13 100	21 300	-	7 100	0.026
HK 3516	35	42	16	18 700	33 500	-	7 100	0.032
HK 3520	35	42	20	23 800	46 000	-	7 100	0.046
HK 4012	40	47	12	14 000	24 300	-	6 300	0.029
HK 4016	40	47	16	20 000	38 500	-	6 300	0.039
HK 4018	40	47	18	20 000	38 500	-	6 300	0.045
HK 4020	40	47	20	25 500	52 000	-	6 300	0.054
HK 4512	45	52	12	14 900	27 500	-	5 800	0.035
HK 4516	45	52	16	21 300	43 000	-	5 800	0.044
HK 4518	45	52	18	21 300	43 000	-	5 800	0.050
HK 4520	45	52	20	27 000	59 000	-	5 800	0.060
HK 5020	50	58	20	31 000	63 000	-	5 300	0.069
HK 5022	50	58	22	31 000	63 000	-	5 300	0.075
HK 5024	50	58	24	31 000	63 000	-	5 300	0.083
HK 5025	50	58	25	38 500	84 000	-	5 300	0.092
HK 5520	55	63	20	31 500	67 000	-	4 600	0.078
HK 5528	55	63	28	44 000	103 000	-	4 600	0.111
HK 6012	60	68	12	17 400	32 000	-	4 100	0.049
HK 6020	60	68	20	33 500	75 000	-	4 100	0.086
HK 6032	60	68	32	53 000	135 000	-	4 100	0.136

## Needle Roller Bearings

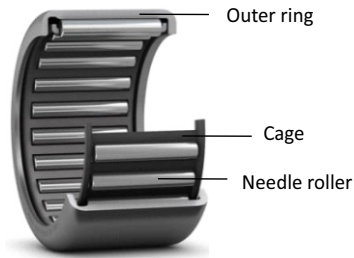
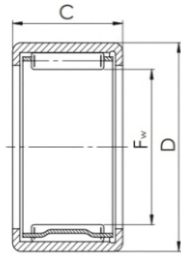

Bearing No.	Boundary dimensions(mm)			Cr(N)	Cor(N)	Limiting Speed (min-1)		Mass (Kg)
	F	D	C			Grease	Oil	
HMK 0810	8	15	10	3800	2870	20000	30000	0.067
HMK 0812	8	15	12	6600	5800	20000	30000	0.100
HMK 0820	8	15	20	9050	8750	20000	30000	0.130
HMK 0912	9	16	12	5300	4450	18000	27000	0.087
HMK 0916	9	16	12	7400	6850	18000	27000	0.120
HMK 1010	10	17	10	4250	3450	16000	24000	0.079
HMK 1012	10	17	12	5600	4850	16000	24000	0.094
HMK 1015	10	17	15	7400	6950	16000	24000	0.120
HMK 1020	10	17	20	1020	1050	16000	24000	0.160
HMK 1212	12	19	12	7100	6900	13000	20000	0.110
HMK 1215	12	19	15	9400	9900	13000	20000	0.140
HMK 1220	12	19	20	1230	1400	13000	20000	0.180
HMK 1510	15	22	10	6100	6000	11000	16000	0.110
HMK 1512	15	22	12	8400	9050	11000	16000	0.130
HMK 1515	15	22	15	1090	1270	11000	16000	0.160
HMK 1520	15	22	20	1490	1890	11000	16000	0.220
HMK 1715	17	24	15	1210	1500	9500	14000	0.180
HMK 1720	17	24	20	1550	2070	9500	14000	0.240
HMK 1725	17	24	25	1930	2740	9500	14000	0.300
HMK 1813	18	25	13	1020	1220	8500	13000	0.160
HMK 1815	18	25	15	1200	1510	8500	13000	0.190
HMK 1817	18	25	17	1380	1800	8500	13000	0.210
HMK 1819	18	25	19	1550	2090	8500	13000	0.240
HMK 1820	18	25	20	1630	2230	8500	13000	0.250
HMK 1825	18	25	25	2030	2960	8500	13000	0.310
HMK 1916	19	27	16	1390	1630	8500	13000	0.250
HMK 1920	19	27	20	1750	2210	8500	13000	0.310



Drawn Cup Needle Roller Bearings

Bearing No.	Boundary dimensions(mm)			Cr(N)	Cor(N)	Limiting Speed (min-1)		Mass (Kg)
	F	D	C			Grease	Oil	
HMK 2020	20	27	20	1 770	2 560	8 000	12 000	0.270
HMK 2015	20	27	15	1 300	1 730	8 000	12 000	0.210
HMK 2025	20	27	25	2 200	3 400	8 000	12 000	0.370
HMK 2030	20	27	30	2 610	4 200	8 000	12 000	0.710
HMK 2116	21	29	16	1 530	1 910	7 500	11 000	0.270
HMK 2120	21	29	20	1 940	2 580	7 500	11 000	0.330
HMK 2210	22	29	10	8 400	1 010	7 500	11 000	0.150
HMK 2215	22	29	15	1 340	1 850	7 500	11 000	0.220
HMK 2220	22	29	20	1 820	2 740	7 500	11 000	0.300
HMK 2225	22	29	25	2 360	3 850	7 500	11 000	0.370
HMK 2230	22	29	30	2 690	4 500	7 500	11 000	0.450
HMK 2420	24	31	20	1 880	2 920	6 500	10 000	0.320
HMK 2428	24	31	28	2 600	4 450	6 500	1 000	0.450
HMK 2510	25	33	10	9 150	1 040	6 500	9 500	0.190
HMK 2515	25	33	15	1 580	2 100	6 500	9 500	0.290
HMK 2520	25	33	20	2 180	3 150	6 500	9 500	0.390
HMK 2525	25	33	25	2 670	4 100	6 500	9 500	0.480
HMK 2530	25	33	30	3 250	5 300	6 500	9 500	0.580
HMK 2616	26	34	16	1 710	2 340	6 000	9 000	0.320
HMK 2620	26	34	20	2 160	3 150	6 000	9 000	0.400
HMK 2820	28	37	20	2 360	3 250	5 500	8 500	0.490
HMK 2830	28	37	30	3 500	5 450	5 500	8 500	0.730
HMK 2920	29	38	20	2 460	3 500	5 500	8 500	0.500
HMK 2930	29	38	30	3 450	5 400	5 500	8 500	0.750

## Needle Roller Bearings

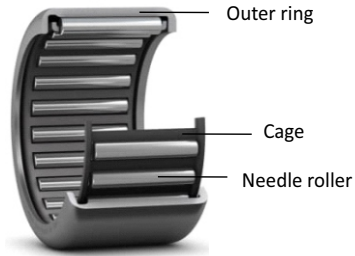
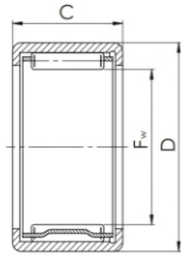

Bearing No.	Boundary dimensions(mm)			Cr(N)	Cor(N)	Limiting Speed (min <sup>-1</sup> )		Mass (Kg)
	F	D	C			Grease	Oil	
HMK 3015	30	40	15	1710	2210	5500	8000	0.400
HMK 3020	30	40	20	1900	3200	5500	8000	0.000
HMK 3025	30	40	25	3150	4850	5500	8000	0.000
HMK 3030	30	40	30	3600	5750	5500	8000	0.870
HMK 3220	32	42	20	2550	3700	5200	7800	0.000
HMK 3230	32	42	30	4150	6450	5000	7500	0.920
HMK 3512	35	45	12	1490	1760	4700	7000	0.400
HMK 3515	35	45	15	2020	2620	4700	7000	0.500
HMK 3520	35	45	20	2700	4300	4700	7000	0.000
HMK 3525	35	45	25	3600	5450	4700	7000	0.830
HMK 3530	35	45	30	3850	7000	4500	6800	0.000
HMK 3720	37	47	20	2930	4300	4300	6500	0.700
HMK 3730	37	47	30	4450	7300	4300	6500	1.050
HMK 3825	38	48	25	3850	6100	4300	6500	0.900
HMK 3830	38	48	30	4600	7700	4300	6500	1.070
HMK 4015	40	50	15	2310	3250	4000	6000	0.560
HMK 4020	40	50	20	3000	4500	4000	6000	0.000
HMK 4025	40	50	25	4100	6750	4000	6000	0.940
HMK 4030	40	50	30	4900	8500	4000	6000	1.120
HMK 4525	45	55	25	4150	7150	3700	5500	1.040
HMK 4530	45	55	30	4950	9000	3700	5500	1.250
HMK 5020	50	62	20	3750	6000	3200	4800	1.120



Drawn Cup Needle Roller Bearings

Bearing No.	Boundary dimensions(mm)			Cr(N)	Cor(N)	Limiting Speed (min-1)		Mass (Kg)
	F	D	C			Grease	Oil	
HKS 8X13X10	8	13	10	5 000	6 500	-	20 000	
HKS 10X15X15	10	15	15	6 800	8 800	-	18 000	
HKS 12X16X12	12	16	12	4 500	5 800	-	19 000	
HKS 13X19X14.2	13	19	14.2	6 200	7 100	-	16 000	
HKS 17X25X18	17	25	18	10 000	12 000	-	12 000	
HKS 17X25X20	17	25	20	10 500	12 500	-	11 000	
HKS 20X26X14	20	26	14	13 000	20 000	-	11 000	
HKS 20X29X18	20	29	18	20 000	25 000	-	10 000	
HKS 26X32X10	26	32	10	9 000	10 500	-	9 000	
HKS 28X35X25	30	38	12	20 000	36 000	-	8 500	
HKS 28X35X30	30	38	16	20 000	37 000	-	8 100	
HKS 28X35X33	30	38	24	20 000	38 000	-	8 100	
HKS 28X36X25	28	36	25	24 000	40 000	-	8 000	
HKS 30X37X30	30	37	30	28 500	54 000	-	7 800	
HKS 32X39X34	32	39	34	36 000	58 000	-	7 800	
HKS 32X40X30	32	40	30	36 000	58 000	-	8 000	
HKS 35X41X26	35	41	26	36 000	54 500	-	7 000	
HKS 35X43X20	35	43	20	24 200	47 100	-	7 100	
HKS 36X44X30	36	44	20	28 400	40 500	-	7 000	
HKS 40X48X20	40	48	20	25 500	52 000	-	6 000	
HKS 41X47X12	41	47	12	15 000	25 000	-	6 000	
HKS 45X52X12	45	55	38	55 000	80 000	-	5 300	
HKS 50X58X12	50	57	16	15 200	20 000	-	4 800	

## Needle Roller Bearings

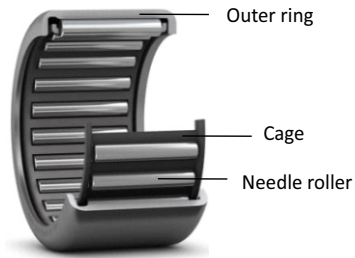
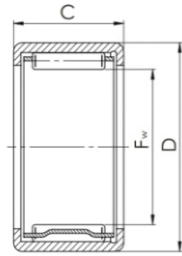

Bearing No.	Boundary dimensions(mm)			Cr(N)	Cor(N)	Limiting Speed (min-1)		Mass (Kg)
	F	D	C			Grease	Oil	
BA 1010	15.875	20.638	15.880	750	1 100	-	25 000	0.010
BA 1012	15.875	20.638	19.050	920	1 430	-	25 000	0.013
BA 105	15.875	20.638	7.940	290	330	-	25 000	0.005
BA 107	15.875	20.638	11.110	510	680	-	25 000	0.008
BA 108	15.875	20.638	12.700	550	740	-	25 000	0.008
BA 118	17.462	22.225	12.700	630	900	-	25 000	0.010
BA 1210	19.050	25.400	15.880	970	1 350	-	20 000	0.017
BA 1212	19.050	25.400	19.050	1 220	1 800	-	20 000	0.022
BA 126	19.050	25.400	9.520	510	600	-	20 000	0.010
BA 128	19.050	25.400	12.700	700	890	-	20 000	0.014
BA 128	19.050	25.400	12.700	700	890	-	20 000	0.014
BA 1412	22.225	28.575	19.050	1 310	2 080	-	18 000	0.022
BA 1416	22.225	28.575	25.400	1 790	3 110	-	18 000	0.034
BA 146	22.225	28.575	9.520	550	690	-	18 000	0.012
BA 148	22.225	28.575	12.700	760	1 080	-	18 000	0.016
BA 1612	25.400	31.750	19.050	1 450	2 470	-	15 000	0.027
BA 1616	25.400	31.750	25.400	1 980	3 700	-	15 000	0.036
BA 1816	28.575	34.925	25.400	2 090	4 110	-	13 000	0.039
BA 188	28.575	34.925	12.700	880	1 360	-	13 000	0.020
BA 1916	30.162	38.100	25.400	2 630	4 620	-	12 000	0.052





Drawn Cup Needle Roller Bearings

Bearing No.	Boundary dimensions(mm)			Cr(N)	Cor(N)	Limiting Speed (min-1)		Mass (Kg)
	F	D	C			Grease	Oil	
BA 2012	31.750	38.100	19.050	1 600	3 020	-	12 000	0.033
BA 2016	31.750	38.100	25.400	2 190	4 520	-	12 000	0.050
BA 2020	31.750	38.100	31.750	2 750	6 040	-	12 000	0.054
BA 2216	34.925	41.275	25.400	2 350	5 120	-	10 000	0.048
BA 2420	38.100	47.625	31.750	3 980	7 570	-	9 000	0.098
BA 2610	41.275	50.800	15.880	1 930	3 060	-	8 000	0.052
BA 2620	41.275	50.800	31.750	4 220	8 370	-	8 000	0.105
BA 2812	44.450	53.975	19.050	2 570	4 540	-	7 500	0.068
BA 2816	44.450	53.975	25.400	3 540	6 870	-	7 500	0.091
BA 3216	50.800	60.325	25.400	3 780	7 800	-	6 000	0.104
BA 44	6.350	11.112	6.350	150	110	-	55 000	0.002
BA 47	6.350	11.112	11.130	270	240	-	55 000	0.004
BA 55	7.938	12.700	7.920	190	160	-	45 000	0.003
BA 57	7.938	12.700	11.130	340	330	-	45 000	0.004
BA 610	9.525	14.288	15.880	580	680	-	40 000	0.007
BA 66	9.525	14.288	9.525	320	310	-	40 000	0.004
BA 68	9.525	14.288	12.700	430	470	-	40 000	0.006
BA 810	12.700	17.462	15.880	650	850	-	30 000	0.009
BA 812	12.700	17.462	19.050	800	1120	-	30 000	0.011
BA 88	12.700	17.462	12.700	480	580	-	30 000	0.007
BA 910	14.288	19.050	15.880	720	1010	-	30 000	0.010

## Needle Roller Bearings

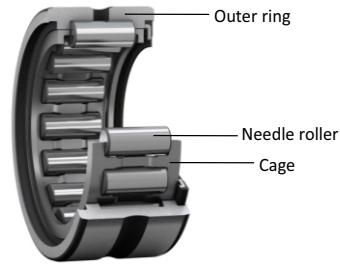
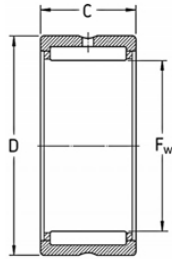

Bearing No.	Boundary dimensions(mm)			r(mm)	Cr(N)	Cor(N)	Limiting Speed (min <sup>-1</sup> )		Mass (Kg)
	F	D	C				Grease	Oil	
NK 10/12	10	17	12	0.3	4 750	5 300	-	29 000	0.011
NK 10/16	10	17	16	0.3	6 200	7 800	-	29 000	0.014
NK 10/16	10	17	16	0.3	6 200	7 800	-	29 000	0.014
NK 12/12	12	19	12	0.3	6 000	6 400	-	27 000	0.012
NK 12/16	12	19	16	0.3	8 200	9 800	-	27 000	0.016
NK 14/16	14	22	16	0.3	10 100	11 500	-	25 000	0.021
NK 14/20	14	22	20	0.3	12 800	15 600	-	25 000	0.027
NK 15/12	15	23	12	0.3	8 600	11 000	-	21 000	0.019
NK 15/16	15	23	16	0.3	10 700	12 700	-	24 000	0.023
NK 15/20	15	23	20	0.3	13 600	17 200	-	24 000	0.028
NK 16/16	16	24	16	0.3	11 300	13 900	-	23 000	0.023
NK 16/20	16	24	20	0.3	10 400	16 800	-	23 000	0.029
NK 17/16	17	25	16	0.3	9 000	13 500	-	14 000	0.025
NK 17/20	17	25	20	0.3	15 000	20 000	-	23 000	0.031
NK 18/16	18	26	16	0.3	12 500	16 200	-	22 000	0.026
NK 18/20	18	26	20	0.3	15 500	19 800	-	22 000	0.032
NK 19/16	19	27	16	0.3	13 000	17 000	-	22 000	0.027
NK 20/16	20	28	16	0.3	10 500	13 800	-	21 000	0.028
NK 20/16	20	32	16	0.3	13 000	25 000	-	12 000	0.028
NK 20/20	20	28	20	0.3	11 500	21 800	-	21 000	0.036
NK 21/16	21	29	16	0.3	13 500	18 700	-	21 000	0.029
NK 21/20	21	29	20	0.3	18 300	27 000	-	19 000	0.036
NK 22/16	22	30	16	0.3	13 500	18 000	-	11 500	0.030
NK 22/20	22	30	20	0.3	17 000	26 000	-	18 000	0.038
NK 24/16	24	32	16	0.3	13 500	20 200	-	17 000	0.032
NK 25/16	25	33	16	0.3	12 900	20 400	-	15 000	0.034
NK 25/20	25	33	20	0.3	16 800	28 500	-	15 000	0.042
NK 25/30	25	33	30	0.3	18 800	30 500	-	16 000	0.053
NK 26/16	26	34	16	0.3	15 000	23 000	-	16 300	0.035
NK 26/20	26	34	20	0.3	17 000	30 000	-	16 300	0.044
NK 28/20	28	37	20	0.3	22 000	34 000	-	16 500	0.052
NK 28/30	28	37	30	0.3	33 000	57 000	-	12 000	0.084
NK 29/20	29	38	20	0.3	21 900	34 000	-	15 000	0.057



Single Row With Machined Ring

Bearing No.	Boundary dimensions(mm)			r(mm)	Cr(N)	Cor(N)	Limiting Speed (min-1)		Mass (Kg)
	F	D	C				Grease	Oil	
NK 29/30	29	38	30	0.3	32 500	57 000	-	15 000	0.085
NK 30/20	30	40	20	0.3	20 600	32 000	-	15 000	0.065
NK 30/30	30	40	30	0.3	31 500	50 000	-	15 000	0.098
NK 32/20	32	42	20	0.3	22 600	33 500	-	15 000	0.068
NK 32/30	32	42	30	0.3	33 500	60 000	-	12 000	0.102
NK 35/20	35	45	20	0.3	13 800	26 900	-	12 000	0.074
NK 37/20	37	47	20	0.3	24 900	43 500	-	12 000	0.078
NK 37/30	37	47	30	0.3	37 000	73 000	-	12 000	0.117
NK 38/20	38	48	20	0.3	25 500	45 000	-	12 000	0.079
NK 38/30	38	48	30	0.3	38 000	76 000	-	12 000	0.119
NK 40/20	40	50	20	0.3	26 500	43 000	-	11 000	0.083
NK 40/30	40	50	30	0.3	37 500	79 000	-	11 000	0.125
NK 42/20	42	52	20	0.3	23 900	45 000	-	10 000	0.087
NK 42/30	42	52	30	0.3	27 000	49 000	-	10 000	0.130
NK 43/20	43	53	20	0.3	25 700	75 000	-	10 000	0.089
NK 43/30	43	53	30	0.3	39 000	75 000	-	10 000	0.133
NK 45/20	45	55	20	0.3	19 800	46 500	-	7 650	0.092
NK 45/30	45	55	30	0.3	41 000	88 000	-	7 650	0.138
NK 47/20	47	57	20	0.3	28 500	56 000	-	7 650	0.095
NK 47/30	47	57	30	0.3	43 000	94 000	-	7 650	0.144
NK 50/14	50	64	14	0.6	32 000	70 100	-	8 140	0.170
NK 50/15	50	65	15	0.6	40 000	62 000	-	8 140	0.180
NK 55/25	55	68	25	0.6	30 600	60 800	-	7 600	0.193

## Needle Roller Bearings

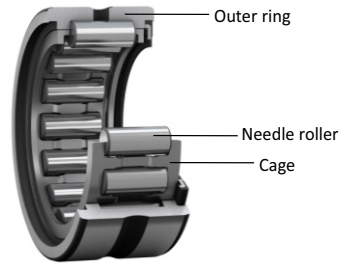
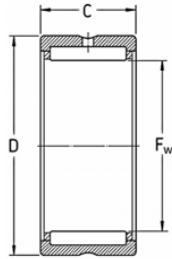

Bearing No.	Boundary dimensions(mm)			r(mm)	Cr(N)	Cor(N)	Limiting Speed (min-1)		Mass (Kg)
	F	D	C				Grease	Oil	
NK 55/30	55	68	30	0.6	48 000	63 000	-	7 600	0.210
NK 55/35	55	68	35	0.6	55 000	74 000	-	7 600	0.255
NK 60/25	60	72	25	0.6	39 000	86 000	-	7 000	0.187
NK 60/35	60	72	35	0.6	56 000	130 000	-	7 000	0.260
NK 65/25	65	78	25	0.6	44 000	98 000	-	7 000	0.225
NK 65/35	65	78	35	0.6	59 000	142 000	-	7 000	0.315
NK 68/25	68	82	25	0.6	43 500	89 000	-	7 000	0.250
NK 70/25	70	85	25	0.6	44 500	92 000	-	6 500	0.280
NK 70/35	70	85	35	0.6	63 000	144 000	-	6 500	0.395
NK 75/25	75	92	25	0.6	54 000	104 000	-	6 000	0.345
NK 75/35	75	92	35	0.6	77 000	162 000	-	6 000	0.435
NK 80/25	80	95	25	1	56 000	118 000	-	6 000	0.280
NK 80/35	80	95	35	1	75 000	182 000	-	6 000	0.398
NK 85/25	85	105	25	1	69 000	123 000	-	5 500	0.445
NK 85/35	85	105	35	1	98 000	193 000	-	5 500	0.610
NK 90/35	90	110	30	1	103 000	20 800	-	5 000	0.640
NK 95/26	95	115	26	1	73 000	137 000	-	4 800	0.468
NK 95/36	95	115	36	1	107 000	223 000	-	4 800	0.660
NK 100/36	100	120	36	1	111 000	237 000	-	4 600	0.690
NK 105/26	105	125	26	1	78 000	155 000	-	4 000	0.509
NK 105/36	105	125	36	1	114 000	250 000	-	4 000	0.715
NK 110/30	110	130	30	1	98 000	21 000	-	4 200	0.615
NK 110/40	110	130	40	1	127 000	29 000	-	4 200	0.820



Single Row With Machined Ring

Bearing No.	Boundary dimensions(mm)			r(mm)	Cr(N)	Cor(N)	Limiting Speed (min-1)		Mass (Kg)
	F	D	C				Grease	Oil	
NKS 10	10	19	13		5 800	6 000	-	29 000	0.015
NKS 14	14	25	16		1 400	13 800	-	24 000	0.029
NKS 16	16	28	16		14 900	15 000	-	20 000	0.035
NKS 20	20	32	20		20 000	23 000	-	20 000	0.059
NKS 22	22	35	20		21 500	25 000	-	17 000	0.062
NKS 25	25	38	20		25 800	31 000	-	16 300	0.069
NKS 28	28	42	20		25 900	33 500	-	15 000	0.085
NKS 30	30	45	17		32 000	40 000	-	14 000	0.104
NKS 32	32	47	22		31 000	40 000	-	13 000	0.110
NKS 40	40	55	22		38 000	54 000	-	11 000	0.129
NKS 45	45	60	22		40 500	60 000	-	7 650	0.145
NKS 50	50	65	22		42 000	68 000	-	7 600	0.157
NKS 55	55	72	22		45 000	74 000	-	7 600	0.249
NKS 60	60	80	28		63 000	98 000	-	7 000	0.335
NKS 65	65	85	28		67 000	108 000	-	7 000	0.356

## Needle Roller Bearings

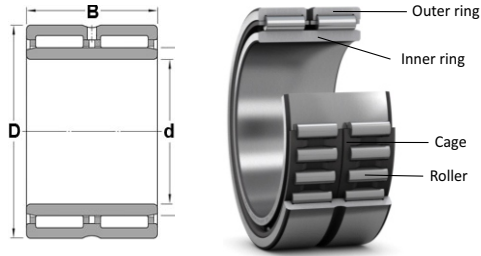

Bearing No.	Boundary dimensions(mm)			r(mm)	Cr(N)	Cor(N)	Limiting Speed (min-1)		Mass (Kg)
	d	D	B				Grease	Oil	
NA 4822	110	140	30	1.0	93 200	239 000	-	3 500	1.100
NA 4824	120	150	30	1.0	96 900	259 000	-	3 000	1.150
NA 4826	130	165	35	1.1	116 000	340 000	-	3 000	1.800
NA 4828	140	175	35	1.1	120 000	363 000	-	2 500	1.950
NA 4830	150	190	40	1.1	168 000	446 000	-	2 500	2.700
NA 4832	160	200	40	1.1	173 000	474 000	-	2 500	2.900
NA 4834	170	215	45	1.1	211 000	567 000	-	1 900	4.000
NA 4836	180	225	45	1.1	218 000	602 000	-	1 900	4.100
NA 4838	190	240	50	1.5	249 000	726 000	-	1 800	5.600
NA 4840	200	250	50	1.5	255 000	766 000	-	1 600	5.750
NA 4844	220	270	50	1.5	266 000	833 000	-	1 500	6.300
NA 4848	240	300	60	2.0	345 000	1 150 000	-	1 300	9.700
NA 4852	260	320	60	2.0	354 000	1 220 000	-	1 100	10.200
NA 4856	280	350	69	2.0	486 000	1 550 000	-	950	14.900
NA 4860	300	380	80	2.1	610 000	1 900 000	-	900	21.400
NA 4864	320	400	80	2.1	635 000	2 040 000	-	750	23.000
NA 4868	340	420	80	2.1	651 000	2 140 000	-	700	24.000
NA 4872	360	440	80	2.1	680 000	2 320 000	-	650	25.400
NA 4876	380	480	100	2.1	951 000	2 860 000	-	600	42.100



Single Row With Inner Ring



Double Row With Inner Ring

Bearing No.	Boundary dimensions(mm)			r(mm)	Cr(N)	Cor(N)	Limiting Speed (min-1)		Mass (Kg)
	d	D	B				Grease	Oil	
NA 4900	10	22	13	0.3	9 230	10 100	-	30 000	0.024
NA 4901	12	24	13	0.3	9 660	11 100	-	25 000	0.030
NA 4902	15	28	13	0.3	10 900	13 800	-	20 000	0.038
NA 4903	17	30	13	0.3	11 700	15 600	-	18 000	0.040
NA 4904	20	37	17	0.3	21 000	25 000	-	16 000	0.075
NA 4905	25	42	17	0.3	23 700	30 700	-	13 000	0.090
NA 4906	30	47	17	0.3	25 200	34 700	-	11 000	0.102
NA 4907	35	55	20	0.6	32 000	50 100	-	9 500	0.172
NA 4908	40	62	22	0.6	41 600	67 400	-	8 500	0.245
NA 4909	45	68	22	0.6	43 500	73 300	-	7 500	0.270
NA 4910	50	72	22	0.6	46 200	82 100	-	7 000	0.295
NA 4911	55	80	25	1.0	57 600	97 200	-	6 500	0.410
NA 4912	60	85	25	1.0	60 200	105 000	-	6 000	0.435
NA 4913	65	90	25	1.0	62 700	113 000	-	5 500	0.470
NA 4914	70	100	30	1.0	83 200	158 000	-	5 000	0.745
NA 4915	75	105	30	1.0	86 200	169 000	-	4 500	0.780
NA 4916	80	110	30	1.0	87 300	175 000	-	4 500	0.855
NA 4917	85	120	35	1.1	110 000	244 000	-	4 000	1.240
NA 4918	90	125	35	1.1	113 000	258 000	-	4 000	1.300
NA 4919	95	130	35	1.1	116 000	271 000	-	3 500	1.420
NA 4920	100	140	40	1.1	145 000	329 000	-	3 500	1.960
NA 4922	110	150	40	1.1	152 000	357 000	-	3 000	2.100

## Needle Roller Bearings

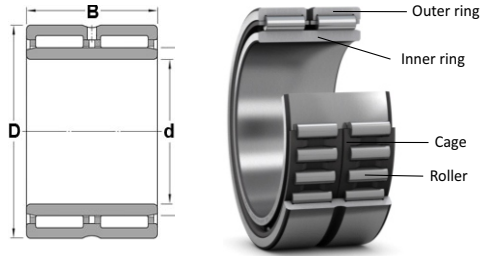

Bearing No.	Boundary dimensions(mm)			r(mm)	Cr(N)	Cor(N)	Limiting Speed (min-1)		Mass (Kg)
	d	D	B				Grease	Oil	
NA 4924	120	165	45	1.1	187 000	435 000	-	3 000	2.850
NA 4926	130	180	50	1.5	215 000	540 000	-	2 500	3.900
NA 4928	140	190	50	1.5	224 000	580 000	-	2 500	4.280
NA 4930	150	210	60	2.0	324 000	712 000	-	2 500	6.380
NA 4932	160	220	60	2.0	337 000	761 000	-	1 900	6.780
NA 4934	170	230	60	2.0	347 000	810 000	-	1 900	7.100
NA 4936	180	250	69	2.0	434 000	989 000	-	1 900	8.500
NA 4938	190	260	69	2.0	440 000	1 020 000	-	1 700	8.680
NA 4940	200	280	80	2.1	518 000	1 120 000	-	1 600	12.000
NA 4944	220	300	80	2.1	536 000	1 200 000	-	1 400	13.100
NA 4948	240	320	80	2.1	565 000	1 320 000	-	1 300	14.600
NA 4952	260	360	100	2.1	847 000	1 900 000	-	1 100	25.800
NA 4956	280	380	100	2.1	877 000	2 040 000	-	950	27.200
NA 4960	300	420	118	3.0	1 130 000	2 650 000	-	850	42.300
NA 4964	320	440	118	3.0	1 170 000	2 830 000	-	750	45.100
NA 4968	340	460	118	3.0	1 220 000	3 020 000	-	700	47.300
NA 4972	360	480	118	3.0	1 260 000	3 200 000	-	600	49.000
NA 4976	380	520	140	4.0	1 540 000	4 030 000	-	500	72.700
NA 4980	400	540	140	4.0	1 590 000	4 270 000	-	500	76.500
NA 4984	420	560	140	4.0	1 640 000	4 510 000	-	500	88.700
NA 4988	440	600	160	4.0	1 910 000	5 140 000	-	400	122.000
NA 49/22	22	39	17	0.3	21 400	28 900	-	14 000	0.080
NA 49/32	32	52	20	0.6	31 200	47 800	-	10 000	0.160
NA 49/28	28	45	17	0.3	24 500	32 700	-	12 000	0.097





Single Row With Inner Ring



Double Row With Inner Ring

Bearing No.	Boundary dimensions(mm)			r(mm)	Cr(N)	Cor(N)	Limiting Speed (min-1)		Mass (Kg)
	d	D	B				Grease	Oil	
NA 6901	12	24	22	0.3	17 100	23 000	-	25 000	0.046
NA 6902	15	28	23	0.3	19 300	28 800	-	20 000	0.064
NA 6903	17	30	23	0.3	20 800	32 500	-	18 000	0.072
NA 6904	20	37	30	0.3	35 400	48 900	-	16 000	0.140
NA 6905	25	42	30	0.3	42 100	64 300	-	13 000	0.160
NA 6906	30	47	30	0.3	43 000	69 000	-	11 000	0.190
NA 6907	35	55	36	0.6	54 900	100 000	-	9 500	0.310
NA 6908	40	62	40	0.6	71 300	135 000	-	8 500	0.420
NA 6909	45	68	40	0.6	74 600	147 000	-	7 500	0.500
NA 6910	50	72	40	0.6	79 200	164 000	-	7 000	0.520
NA 6911	55	80	45	1.0	98 700	194 000	-	6 500	0.780
NA 6912	60	85	45	1.0	103 000	211 000	-	6 000	0.810
NA 6913	65	90	45	1.0	108 000	227 000	-	5 500	0.830
NA 6914	70	100	54	1.0	134 000	311 000	-	5 000	1.350
NA 6915	75	105	54	1.0	138 000	331 000	-	4 500	1.450
NA 6916	80	110	54	1.0	143 000	351 000	-	4 500	1.500
NA 6917	85	120	63	1.1	173 000	467 000	-	4 000	2.200
NA 6918	90	125	63	1.1	178 000	490 000	-	4 000	2.300
NA 69/22	22	39	30	0.3	36 900	57 000	-	14000	0.150
NA 69/28	28	45	30	0.3	41 800	64 800	-	12 000	0.180
NA 69/32	32	52	36	0.6	53 500	95 700	-	10 000	0.290

## Needle Roller Bearings



Bearing No.	Boundary dimensions(mm)			r(mm)	Cr(N)	Cor(N)	Limiting Speed (min-1)		Mass (Kg)
	F	D	C				Grease	Oil	
BR 101812	15.875	28.575	19.050	0.6	1 930	2 010	-	25 000	0.049
BR 122012	19.050	31.750	19.050	1	2 220	2 490	-	20 000	0.056
BR 122016	19.050	31.750	25.400	1	2 810	3 380	-	20 000	0.079
BR 142212	22.225	34.925	19.050	1	2 340	2 770	-	18 000	0.068
BR 142216	22.225	34.925	25.400	1	2 970	3 760	-	18 000	0.090
BR 162412	25.400	38.100	19.050	1	2 580	3 250	-	16 000	0.073
BR 162416	25.400	38.100	25.400	1	3 280	4 420	-	16 000	0.099
BR 182616	28.575	41.275	25.400	1	3 560	5 090	-	14 000	0.102
BR 182620	28.575	41.275	31.750	1	4 410	6 690	-	14 000	0.128
BR 202816	31.750	44.450	25.400	1	3 670	5 450	-	13 000	0.110
BR 202820	31.750	44.450	31.750	1	4 550	7 180	-	13 000	0.138
BR 223016	34.925	47.625	25.400	1	3 930	6 120	-	11 000	0.119
BR 223020	34.925	47.625	31.750	1	4 870	8 060	-	11 000	0.149
BR 243316	38.100	52.388	35.400	1.5	4 460	6 820	-	11 000	0.149
BR 243320	38.100	52.388	31.750	1.5	5 530	8 980	-	11 000	0.187
BR 263516	41.275	55.562	25.400	1.5	4 570	7 230	-	9 500	0.158
BR 263520	41.275	55.562	31.750	1.5	5 670	9 530	-	9 500	0.199
BR 283716	44.450	58.738	25.400	1.5	4 850	7 980	-	9 000	0.170



Double Row Without Inner Rings

Bearing No.	Boundary dimensions(mm)			r(mm)	Cr(N)	Cor(N)	Limiting Speed (min-1)		Mass (Kg)
	F	D	C				Grease	Oil	
BR 283720	44.450	58.738	31.750	1.5	6 010	10 500	-	9 000	0.215
BR 283820	44.450	60.325	31.750	1.5	6 010	10 500	-	9 000	0.250
BR 303920	47.625	61.912	31.750	1.5	6 130	11 000	-	8 500	0.225
BR 324116	50.800	65.000	25.400	1.5	5 200	9 110	-	8 000	0.190
BR 324120	50.800	65.000	31.750	1.5	6 440	12 000	-	8 000	0.240
BR 364824	57.150	76.200	38.100	1.5	9 200	16 100	-	7 000	0.435
BR 364828	57.150	76.200	44.450	1.5	10 700	19 500	-	7 000	0.510
BR 405224	63.500	82.550	38.100	2	9 640	17 700	-	6 500	0.475
BR 405228	63.500	82.550	44.450	2	11 200	21 400	-	6 500	0.555
BR 445624	69.800	88.900	38.100	2	10 100	19 300	-	5 500	0.510
BR 445628	69.800	88.900	44.450	2	11 700	23 300	-	5 500	0.640
BR 486024	76.200	95.250	38.100	2	10 700	21 600	-	5 500	0.555
BR 486028	76.200	95.250	44.450	2	12 400	26 100	-	5 500	0.650
BR 526828	82.550	107.950	44.450	2	14 400	26 400	-	5 000	0.990
BR 526832	82.550	107.950	50.800	2	15 700	29 500	-	5 000	1.122
BR 567232	88.900	114.300	50.800	2	16 500	32 100	-	4 500	1.240
BR 607632	95.250	120.650	50.800	2.5	17 200	34 900	-	4 000	1.320
BR 648032	101.600	127.000	50.800	2.5	18 000	37 500	-	4 000	1.380

## Inner Rings

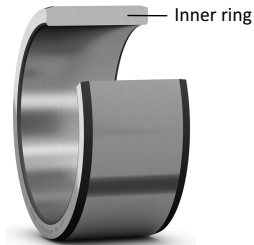
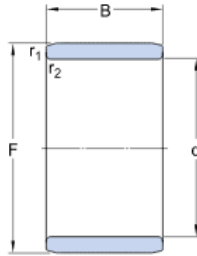

Bearing No.	Boundary dimensions(mm)			r(mm)	Mass (Kg)
	d	F	B		
IR 5X8X12	5	8	12	0.2	0.003
IR 5X8X16	5	8	16	0.2	0.004
IR 6X9X12	6	9	12	0.2	0.003
IR 6X9X16	6	9	16	0.2	0.004
IR 6X10X10	6	10	10	0.3	0.004
IR 6X10X12	6	10	12	0.3	0.004
IR 7X10X12	7	10	12	0.3	0.004
IR 7X10X16	7	10	16	0.3	0.005
IR 8X12X10	8	12	10	0.3	0.005
IR 8X12X12	8	12	12	0.3	0.006
IR 9X12X12	9	12	12	0.3	0.005
IR 9X12X16	9	12	16	0.3	0.006
IR 10X13X12.5	10	13	12.5	0.3	0.005
IR 10X14X12	10	14	12	0.3	0.007
IR 10X14X13	10	14	13	0.3	0.008
IR 10X14X14	10	14	14	0.3	0.008
IR 10X14X16	10	14	16	0.3	0.009
IR 10X14X20	10	14	20	0.3	0.012
IR 12X15X12	12	15	12	0.3	0.006
IR 12X15X16	12	15	16	0.3	0.008
IR 12X16X12	12	16	12	0.3	0.008
IR 12X16X13	12	16	13	0.3	0.009
IR 12X16X14	12	16	14	0.3	0.010
IR 12X16X16	12	16	16	0.3	0.011
IR 12X16X20	12	16	20	0.3	0.014
IR 12X16X22	12	16	22	0.3	0.015
IR 14X17X17	14	17	17	0.3	0.010
IR 15X19X16	15	19	16	0.3	0.013
IR 15X19X20	15	19	20	0.3	0.016
IR 15X20X12	15	20	12	0.3	0.012
IR 15X20X13	15	20	13	0.3	0.014
IR 15X20X14	15	20	14	0.3	0.015
IR 15X20X23	15	20	23	0.3	0.024



Needle Roller Bushing Inner Rings

Bearing No.	Boundary dimensions(mm)			r(mm)	Mass (Kg)
	d	F	B		
IR 17X20X16	17	20	16	0.3	0.013
IR 17X20X20	17	20	20	0.3	0.014
IR 17X21X16	17	21	16	0.3	0.015
IR 17X21X20	17	21	20	0.3	0.018
IR 17X22X13	17	22	13	0.3	0.016
IR 17X22X14	17	22	14	0.3	0.017
IR 17X22X16	17	22	16	0.3	0.019
IR 17X22X23	17	22	23	0.3	0.027
IR 17X24X20	17	24	20	0.3	0.020
IR 20X24X16	20	24	16	0.3	0.017
IR 20X24X20	20	24	20	0.3	0.021
IR 20X25X16	20	25	16	0.3	0.022
IR 20X25X17	20	25	17	0.3	0.023
IR 20X25X18	20	25	18	0.3	0.024
IR 20X25X20	20	25	20	0.3	0.028
IR 20X25X30	20	25	30	0.3	0.041
IR 20X28X20	20	28	20	0.3	0.045
IR 22X26X16	22	26	16	0.3	0.018
IR 22X26X20	22	26	20	0.3	0.024
IR 22X28X17	22	28	17	0.3	0.031
IR 22X28X20	22	28	20	0.3	0.035
IR 22X28X30	22	28	30	0.3	0.055
IR 25X29X20	25	29	20	0.3	0.025
IR 25X29X30	25	29	30	0.3	0.039
IR 25X30X16	25	30	16	0.3	0.026
IR 25X30X17	25	30	17	0.3	0.028
IR 25X30X18	25	30	18	0.3	0.029
IR 25X30X20	25	30	20	0.3	0.034
IR 25X30X30	25	30	30	0.3	0.050
IR 25X30X32	25	30	32	0.3	0.054
IR 25X32X22	25	32	22	0.3	0.051
IR 28X32X17	28	32	17	0.3	0.025
IR 28X32X20	28	32	20	0.3	0.029

## Inner Rings

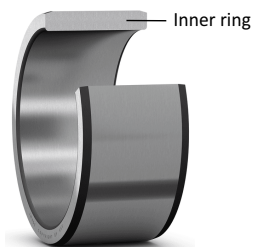
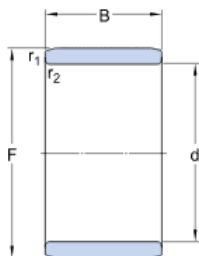

Bearing No.	Boundary dimensions(mm)			r(mm)	Mass (Kg)
	d	F	B		
IR 28X32X30	28	32	30	0.3	0.043
IR 29X32X13	29	32	13	0.3	0.022
IR 30X35X13	30	35	13	0.3	0.027
IR 30X35X16	30	35	16	0.3	0.032
IR 30X35X17	30	35	17	0.3	0.033
IR 30X35X18	30	35	18	0.3	0.035
IR 30X35X20	30	35	20	0.3	0.040
IR 30X35X26	30	35	26	0.3	0.052
IR 30X35X30	30	35	30	0.3	0.059
IR 30X37X18	30	37	18	0.3	0.050
IR 30X37X22	30	37	22	0.3	0.055
IR 30X38X20	30	38	20	0.3	0.065
IR 32X37X20	32	37	20	0.6	0.043
IR 32X37X30	32	37	30	0.6	0.063
IR 32X40X20	32	40	20	0.6	0.069
IR 32X40X36	32	40	36	0.6	0.124
IR 33X37X13	33	37	13	0.6	0.040
IR 35X40X17	35	40	17	0.6	0.039
IR 35X40X20	35	40	20	0.6	0.046
IR 35X40X30	35	40	30	0.6	0.068
IR 35X42X20	35	42	20	0.6	0.065
IR 35X42X21	35	42	21	0.6	0.070
IR 35X42X23	35	42	23	0.6	0.080
IR 35X42X36	35	42	36	0.6	0.117
IR 35X43X22	35	43	22	0.6	0.055
IR 38X43X20	38	43	20	0.6	0.048
IR 38X43X30	38	43	30	0.6	0.074
IR 40X45X17	40	45	17	0.6	0.045
IR 40X45X20	40	45	20	0.6	0.051
IR 40X45X30	40	45	30	0.6	0.077
IR 40X48X22	40	48	22	0.6	0.093
IR 40X48X23	40	48	23	0.6	0.098
IR 40X48X40	40	48	40	0.6	0.170



Needle Roller Bushing Inner Rings

Bearing No.	Boundary dimensions(mm)			r(mm)	Mass (Kg)
	d	F	B		
IR 40X50X20	40	50	20	0.6	0.095
IR 40X50X22	40	50	22	0.6	0.110
IR 42X47X20	42	47	20	0.6	0.054
IR 42X47X30	42	47	30	0.6	0.081
IR 45X50X25	45	50	25	0.6	0.071
IR 45X50X35	45	50	35	0.6	0.101
IR 45X52X22	45	52	22	0.6	0.088
IR 45X52X23	45	52	23	0.6	0.095
IR 45X52X40	45	52	40	0.6	0.165
IR 45X55X20	45	55	20	0.6	0.120
IR 45X55X22	45	55	22	0.6	0.125
IR 50X55X20	50	55	20	0.6	0.063
IR 50X55X25	50	55	25	0.6	0.077
IR 50X55X25	50	55	25	0.6	0.077
IR 50X55X35	50	55	35	0.6	0.112
IR 50X58X22	50	58	22	0.6	0.116
IR 50X58X23	50	58	23	0.6	0.122
IR 50X58X40	50	58	40	0.6	0.210
IR 50X60X20	50	60	20	0.6	0.135
IR 50X60X25	50	60	25	0.6	0.165
IR 50X60X28	50	60	28	0.6	0.190
IR 55X60X25	55	60	25	1	0.086
IR 55X60X35	55	60	35	1	0.121
IR 55X63X25	55	63	25	1	0.141
IR 55X63X45	55	63	45	1	0.256
IR 55X65X28	55	65	28	1	0.220
IR 60X68X25	60	68	25	1	0.152
IR 60X68X35	60	68	35	1	0.210
IR 60X68X45	60	68	45	1	0.275
IR 60X70X25	60	70	25	1	0.195
IR 60X70X28	60	70	28	1	0.210
IR 65X72X25	65	72	25	1	0.145
IR 65X72X45	65	72	45	1	0.264

## Inner Rings

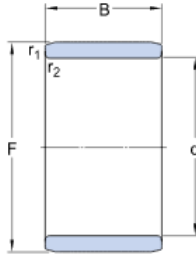

Bearing No.	Boundary dimensions(mm)			r(mm)	Mass (Kg)
	d	F	B		
IR 65X73X25	65	73	25	1	0.165
IR 65X73X35	65	73	35	1	0.235
IR 65X75X28	65	75	28	1	0.200
IR 70X80X25	70	80	25	1	0.225
IR 70X80X30	70	80	30	1	0.275
IR 70X80X35	70	80	35	1	0.310
IR 70X80X54	70	80	54	1	0.490
IR 70X80X56	70	80	56	1	0.560
IR 75X85X25	75	85	25	1	0.240
IR 75X85X30	75	85	30	1	0.290
IR 75X85X35	75	85	35	1	0.335
IR 75X85X54	75	85	54	1	0.520
IR 80X90X25	80	90	25	1	0.255
IR 80X90X30	80	90	30	1	0.310
IR 80X90X35	80	90	35	1	0.355
IR 80X90X54	80	90	54	1	0.550
IR 85X95X26	85	95	26	1.1	0.280
IR 85X95X36	85	95	36	1.1	0.390
IR 85X100X35	85	100	35	1.1	0.575





Needle Roller Bushing Inner Rings

Bearing No.	Boundary dimensions(mm)			r(mm)	Mass (Kg)
	d	F	B		
IR 85X100X63	85	100	63	1.1	1.040
IR 90X100X26	90	100	26	1.1	0.295
IR 90X100X30	90	100	30	1.1	0.355
IR 90X100X36	90	100	36	1.1	0.416
IR 90X105X35	90	105	35	1.1	0.610
IR 90X105X63	90	105	63	1.1	1.100
IR 95X105X26	95	105	26	1.1	0.315
IR 95X105X36	95	105	36	1.1	0.430
IR 95X110X35	95	110	35	1.1	0.650
IR 95X110X63	95	110	63	1.1	1.160
IR 100X110X30	100	110	30	1.1	0.370
IR 100X110X40	100	110	40	1.1	0.505
IR 100X115X40	100	115	40	1.1	0.770
IR 110X120X30	110	120	30	1.1	0.410
IR 110X125X40	110	125	40	1.1	0.840
IR 120X130X30	120	130	30	1.5	0.450
IR 120X135X45	120	135	45	1.5	1.030
IR 130X145X35	130	145	35	1.5	0.860
IR 130X150X50	130	150	50	1.5	1.670

# Cam Follower

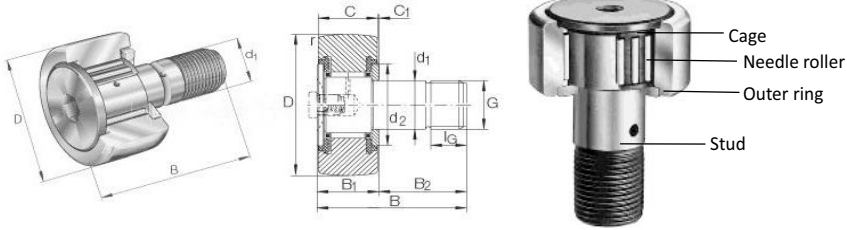

Bearing No.	Boundary dimensions(mm)			r(mm)	Cr(N)	Cor(N)	Limiting Speed (min-1)		Mass (Kg)
	d	D	B				Grease	Oil	
CF 3	3	10	17	0.3	1 400	1 000	25 000	32 000	0.004
CF 4	4	12	20	0.3	1 890	1 640	20 000	26 000	0.007
CF 5	5	13	23	0.3	2 300	2 100	17 000	21 000	0.010
CF 6	6	16	28	0.3	3 150	3 300	18 500	24 000	0.019
CF 8	8	19	32	0.3	3 500	3 900	14 000	19 000	0.032
CF 10	10	22	36	0.3	4 450	5 200	11 000	15 000	0.060
CF 10-1	10	26	36	0.3	5 100	6 200	11 000	15 000	0.074
CF 12	12	30	40	0.6	6 800	8 400	10 000	13 000	0.104
CF 12-1	12	32	40	0.6	7 100	9 000	10 000	13 000	0.110
CF 16	16	35	52	0.6	9 700	14 100	8 000	11 000	0.208
CF 18	18	40	58	0.6	10 900	15 500	7 000	9 000	0.296
CF 20	20	52	66	1	16 800	28 500	5 500	7 500	0.540
CF 20-1	20	47	66	1	15 500	25 500	6 000	7 500	0.385
CF 24	24	62	80	1	26 500	47 500	4 000	6 000	0.784
CF 24-1	24	72	80	1	28 000	53 000	4 500	6 000	1.140
CF 30	30	80	100	1	39 500	77 000	4 000	5 000	1.870
CF 30-1	30	85	100	1	40 500	80 000	3 800	5 200	2.030
CF 30-2	30	90	100	1	41 500	83 000	3 800	5 200	2.220



Bearing No.	Boundary dimensions(mm)			r(mm)	Cr(N)	Cor(N)	Limiting Speed (min-1)		Mass (Kg)
	d	D	B				Grease	Oil	
CR 8-B	4.826	12.700	22.225	0.3	2 300	1 900	20 000	27 000	0.009
CR 10-B	6.350	15.875	26.987	0.3	3 500	3 580	17 000	24 000	0.019
CR 12-B	9.525	19.050	35.719	0.3	4 100	5 000	12 000	15 000	0.035
CR 14-B	9.525	22.225	35.719	0.6	4 650	5 500	12 000	15 000	0.046
CR 16-B	11.112	25.400	42.069	0.6	8 000	9 800	11 000	14 000	0.073
CR 18-B	11.112	28.575	42.069	0.6	8 700	10 500	11 000	14 000	0.088
CR 20-B	12.700	31.750	51.594	1	12 500	14 000	8 000	12 000	0.132
CR 22-B	12.700	34.925	51.594	1	13 300	15 000	8 000	12 000	0.157
CR 24-B	15.875	38.100	61.119	1	17 500	22 300	7 000	9 000	0.225
CR 26-B	15.875	41.275	61.119	1	18 000	23 000	7 000	9 000	0.260
CR 28-B	19.050	44.450	70.644	1	24 900	37 100	5 000	7 000	0.365
CR 30-B	19.050	47.625	70.644	1	24 900	37 100	5 000	7 000	0.410
CR 32-B	22.225	50.800	83.344	1.5	30 000	58 500	4 000	5 800	0.615
CR 36-B	22.225	57.150	83.344	1.5	30 000	58 500	4 000	5 800	0.750

## Rod Ends

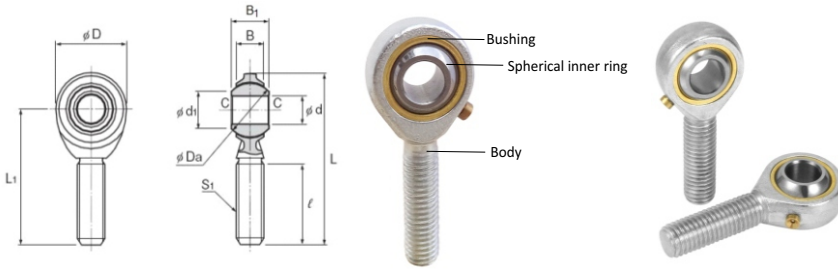

Bearing No.	Boundary dimensions(mm)			r(mm)	Cr(N)	Cor(N)	Mass (Kg)
	d	D	L				
POS 3 L/R	3	12	33	0.3	1 700	1 180	0.005
POS 4 L/R	4	14	37	0.3	2 400	1 800	0.008
POS 5 L/R	5	16	41	0.3	3 100	3 200	0.013
POS 6 L/R	6	18	45	0.3	4 000	4 600	0.019
POS 8 L/R	8	22	53	0.3	6 900	8 400	0.032
POS 10 L/R	10	26	61	0.3	9 500	12 500	0.054
POS 12 L/R	12	30	69	0.3	12 500	16 000	0.085
POS 14 L/R	14	34	77	0.3	16 400	20 000	0.126
POS 16 L/R	16	38	85	0.3	20 000	24 300	0.185
POS 18 L/R	18	42	93	0.3	24 800	29 500	0.260
POS 20 L/R	20	46	101	0.3	30 500	35 000	0.340
POS 22 L/R	22	50	109	0.3	37 000	41 300	0.435
POS 25 L/R	25	60	124	0.3	46 500	72 000	0.650
POS 28 L/R	28	66	136	0.3	57 600	82 400	0.875
POS 30 L/R	30	70	145	0.3	61 200	85 600	1.070



Bearing No.	Boundary dimensions(mm)			r(mm)	Cr(N)	Cor(N)	Mass (Kg)
	d	D	L				
PHS 3 L/R	3	12	27	0.3	1 700	1 180	0.006
PHS 4 L/R	4	14	31	0.3	2 400	1 800	0.012
PHS 5 L/R	5	16	35	0.3	3 100	3 200	0.017
PHS 6 L/R	6	18	39	0.3	4 000	4 600	0.025
PHS 8 L/R	8	22	47	0.3	6 900	8 400	0.043
PHS 10 L/R	10	26	56	0.3	9 500	12 500	0.072
PHS 12 L/R	12	30	65	0.3	1,500	16 000	0.107
PHS 14 L/R	14	34	74	0.3	16 400	20 000	0.160
PHS 16 L/R	16	38	83	0.3	20 000	24 300	0.210
PHS 18 L/R	18	42	92	0.3	24 800	29 500	0.295
PHS 20 L/R	20	46	100	0.3	30 500	35 000	0.380
PHS 22 L/R	22	50	109	0.3	37 000	41 300	0.490
PHS 25 L/R	25	60	124	0.3	46 500	72 000	0.716
PHS 28 L/R	28	66	136	0.3	57 600	82 400	0.950
PHS 30 L/R	30	70	145	0.3	61 200	85 600	1.130

## Spherical Plain Bushings

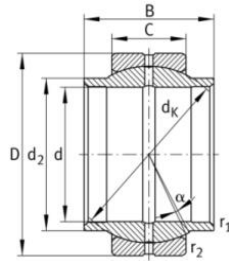

Bearing No.	Boundary dimensions(mm)				r(mm)	Cr(N)	Cor(N)	Mis-alignmet angle $\alpha$	Mass (Kg)
	d	D	C	B					
GE 4E	4	12	3	5	0.3	2 000	10 000	16	0.003
GE 5E	5	14	4	6	0.3	3 400	17 000	13	0.004
GE 6E	6	14	4	6	0.3	3 400	17 000	13	0.004
GE 8E	8	16	5	8	0.3	5 500	27 000	15	0.008
GE 10E	10	19	6	9	0.3	8 100	40 000	12	0.012
GE 12E	12	22	7	10	0.3	10 000	53 000	10	0.017
GE 15ES	15	26	9	12	0.3	16 000	84 000	8	0.028
GE 17ES	17	30	10	14	0.3	21 000	106 000	10	0.040
GE 20ES	20	35	12	16	0.3	30 000	146 000	9	0.066
GE 25ES	25	42	16	20	0.6	48 000	240 000	7	0.114
GE 30ES	30	47	18	22	0.6	62 000	310 000	6	0.152
GE 35ES	35	55	20	25	0.6	79 000	399 000	6	0.230
GE 40ES	40	62	22	28	0.6	99 000	495 000	7	0.318
GE 45ES	45	68	25	32	0.6	127 000	637 000	7	0.428
GE 50ES	50	75	28	35	0.6	156 000	780 000	6	0.560
GE 60ES	60	90	36	44	1	245 000	1 220 000	6	1.018
GE 70ES	70	105	40	49	1	313 000	1 560 000	6	1.550
GE 80ES	80	120	45	55	1	400 000	2 000 000	6	2.292
GE 90ES	90	130	50	60	1	488 000	2 440 000	5	2.716
GE 100ES	100	150	55	70	1	607 000	3 030 000	7	4.276
GE 110ES	110	160	55	70	1	654 000	3 270 000	6	4.940
GE 120ES	120	180	70	85	1	950 000	4 750 000	6	8.160
GE 140ES	140	210	70	90	1	1 070 000	5 350 000	7	11.400
GE 160ES	160	230	80	105	1	1 360 000	6 800 000	8	14.400
GE 180ES	180	260	80	105	1.1	1 530 000	7 650 000	6	18.300
GE 180ES	180	260	80	105	1.1	1 530 000	7 650 000	6	18.300
GE 200ES	200	290	100	130	1.1	2 120 000	10 600 000	7	27.980
GE 220ES	220	320	100	135	1.1	2 320 000	11 600 000	8	36.100
GE 240ES	240	340	100	140	1.1	2 550 000	12 700 000	8	40.400
GE 260ES	260	370	110	150	1.1	3 030 000	15 190 000	7	52.000
GE 280ES	280	400	120	155	1.1	3 570 000	17 850 000	6	66.000
GE 300ES	300	430	120	165	1.1	3 800 000	19 100 000	7	76.000



Without Seal



With Seal

Bearing No.	Boundary dimensions(mm)				r(mm)	Cr(N)	Cor(N)	Mis-alignmet angle $\alpha$	Mass (Kg)
	d	D	H	H					
SBB 8	12.700	22.225	9.525	11.100	0.2	2 900	9 200	6	0.020
SBB 10	15.875	26.988	11.913	13.894	0.2	4 900	14 600	6	0.036
SBB 12	19.050	31.750	14.275	16.662	0.6	7 000	21 400	6	0.057
SBB 14	22.225	36.513	16.662	19.202	0.6	9 400	28 500	6	0.085
SBB 16	25.400	41.275	19.050	22.225	0.6	12 600	37 300	6	0.125
SBB 20	31.750	50.800	23.800	27.762	0.6	19 300	58 400	6	0.234
SBB 22	34.925	55.563	26.187	30.150	0.6	22 900	69 700	5	0.349
SBB 24	38.100	61.913	28.575	33.325	0.6	28 100	84 300	6	0.424
SBB 28	44.450	71.438	33.325	38.887	0.6	38 200	114 600	6	0.649
SBB 32	50.800	80.963	38.100	44.450	0.6	50 400	150 600	6	0.939
SBB 36	57.150	90.488	42.850	50.013	0.6	63 000	191 100	6	1.320
SBB 40	63.500	100.013	47.625	55.550	0.6	79 800	238 300	6	1.850
SBB 44	69.850	111.125	52.375	61.112	0.6	93 300	281 000	6	2.440
SBB 48	76.200	120.650	57.150	66.675	0.6	112 400	337 200	6	3.120
SBB 52	82.550	130.175	61.900	72.238	0.6	131 500	395 600	6	3.920
SBB 56	88.900	139.700	66.675	77.775	0.6	152 900	458 600	6	4.830
SBB 60	95.250	149.225	71.425	83.337	0.6	175 300	530 500	6	5.870
SBB 64	101.600	158.750	76.200	88.900	0.6	202 300	595 700	6	7.070
SBB 68	107.950	168.275	80.950	94.463	0.8	224 800	674 900	6	8.460
SBB 72	114.300	177.800	85.725	100.000	0.8	251 800	764 300	6	9.940
SBB 76	120.650	187.325	90.475	105.562	0.8	281 000	843 000	6	11.600
SBB 80	127.000	196.850	95.250	111.125	0.8	314 700	932 900	6	13.500
SBB 96	152.400	222.250	104.775	120.650	0.8	388 900	1 168 900	5	17.600





**ASB<sup>®</sup>** | 

**Tapered  
Roller  
Bearings** | 



# Tapered Roller Bearings

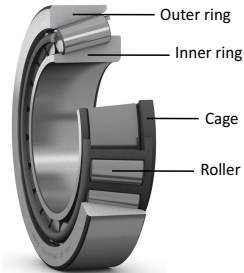
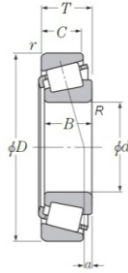

Bearing No.	Boundary dimensions(mm)			r(mm)	Cr(N)	Cor(N)	Limiting Speed (min <sup>-1</sup> )		Mass (Kg)
	d	D	B				Grease	Oil	
30202	15	35	11.75	0.6	14 300	13 000	12 000	16 000	0.060
30203	17	40	13.25	1	18 700	18 700	10 000	14 000	0.082
30204	20	47	15.25	1	24 300	24 500	8 700	12 000	0.126
30205	25	52	16.25	1	28 300	30 300	7 500	10 000	0.160
30206	30	62	17.25	1	37 400	40 300	6 500	8 700	0.230
30207	35	72	18.25	1.5	49 500	54 800	5 600	7 400	0.336
30208	40	80	19.75	1.5	56 600	62 300	5 000	6 700	0.426
30209	45	85	20.75	1.5	60 500	69 700	4 600	6 100	0.480
30210	50	90	21.75	1.5	68 900	82 500	4 300	5 700	0.540
30211	55	100	22.75	2	85 200	101 000	3 900	5 200	0.740
30212	60	110	23.75	2	95 400	114 000	3 500	4 700	0.880
30213	65	120	24.75	2	115 200	140 000	3 200	4 300	1.134
30214	70	125	26.25	2	124 200	155 000	3 100	4 100	1.272
30215	75	130	27.25	2	127 800	163 000	2 900	3 900	1.394
30216	80	140	28.25	2.5	144 900	182 000	2 700	3 600	1.680
30217	85	150	30.5	2.5	163 800	208 000	2 500	3 400	2.086
30218	90	160	32.5	2.5	183 600	235 000	2 400	3 200	2.570
30219	95	170	34.5	3	207 900	269 000	2 200	3 000	3.120
30220	100	180	37	3	232 200	304 000	2 100	2 800	3.778



Bearing No.	Boundary dimensions(mm)			r(mm)	Cr(N)	Cor(N)	Limiting Speed (min-1)		Mass (Kg)
	d	D	B				Grease	Oil	
30221	105	190	39	3	259 200	342 000	2 000	2 600	4.440
30222	110	200	41	3	291 600	390 000	1 900	2 500	5.116
30224	120	215	43.5	3	312 300	425 000	1 700	2 300	6.140
30226	130	230	43.75	4	339 300	460 000	1 600	2 100	7.600
30228	140	250	45.75	4	364 500	484 000	1 500	1 900	8.650
30230	150	270	49	4	420 000	562 000	1 300	1 800	11.000
30232	160	290	52	4	434 700	574 000	1 200	1 600	13.800
30234	170	310	57	5	489 600	653 000	1 100	1 500	17.000
30236	180	320	57	5	553 500	783 000	1 100	1 400	17.400
30238	190	340	60	5	655 000	927 000	1 000	1 400	24.000
30240	200	360	64	5	712 800	1 008 000	940	1 200	25.000
30244	220	400	72	5	909 000	1 296 000	830	1 100	34.000
30248	240	440	79	5	1 107 000	1 600 000	730	980	49.500
30252	260	480	89	6	1 089 000	1 670 000	650	870	64.000
30256	280	500	89	6	1 134 000	1 720 000	610	810	67.500
30260	300	540	96	6	1 359 000	2 120 000	550	730	84.700
30264	320	580	104	6	1 566 000	2 490 000	490	660	108.000

## Tapered Roller Bearings

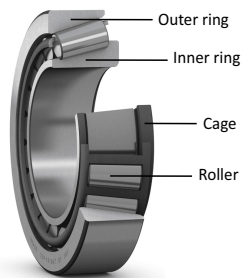
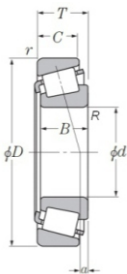

Bearing No.	Boundary dimensions(mm)			r(mm)	Cr(N)	Cor(N)	Limiting Speed (min-1)		Mass (Kg)
	d	D	B				Grease	Oil	
30302	15	42	14.25	1	19 700	17 300	10 000	14 000	0.096
30303D	17	47	15.25	1	19 800	18 300	8 000	11 000	0.138
30303	17	47	15.25	1	24 700	22 000	9 200	12 000	0.132
30304	20	52	16.25	1.5	32 800	31 700	8 300	11 000	0.168
30305D	25	62	18.25	1.5	35 800	38 300	5 700	8 000	0.270
30305	25	62	18.25	1.5	43 400	42 200	6 800	9 000	0.260
30306D	30	72	20.75	1.5	45 800	49 500	4 900	6 800	0.396
30306	30	72	20.75	1.5	53 600	54 000	5 800	7 700	0.392
30307D	35	80	22.75	2	56 800	62 200	4 300	6 000	0.532
30307	35	80	22.75	2	68 500	71 000	5 200	6 900	0.509
30308D	40	90	25.25	2	72 500	81 200	3 800	5 300	0.728
30308	40	90	25.25	2	81 500	91 000	4 500	6 100	0.750
30309D	45	100	27.25	2	85 600	96 300	3 400	4 700	0.940
30309	45	100	27.25	2	102 000	115 000	4 100	5 400	0.984
30310D	50	110	29.25	2.5	104 000	119 000	3 100	4 300	1.224
30310	50	110	29.25	2.5	123 000	137 000	3 700	4 900	1.292
30311D	55	120	31.5	2.5	116 000	134 000	2 900	4 000	1.536
30311	55	120	31.5	2.5	134 000	153 000	3 300	4 500	1.626
30312D	60	130	33.5	3	138 000	161 000	2 600	3 700	1.936
30312	60	130	33.5	3	155 000	180 000	3 100	4 100	2.026
30313D	65	140	36	3	159 000	188 000	2 400	3 400	2.402
30313	65	140	36	3	183 000	215 000	2 800	3 800	2.466
30314D	70	150	38	3	178 000	219 000	2 300	3 200	2.876
30314	70	150	38	3	207 000	245 000	2 600	3 500	2.994
30315	75	160	40	3	225 000	267 000	2 500	3 300	3.614
30315D	75	160	40	3	200 000	239 000	2 100	2 900	3.460
30316D	80	170	42.5	3	212 000	254 000	2 000	2 800	4.094
30316	80	170	42.5	3	265 000	300 000	2 300	3 100	4.264



Bearing No.	Boundary dimensions(mm)			r(mm)	Cr(N)	Cor(N)	Limiting Speed (min-1)		Mass (Kg)
	d	D	B				Grease	Oil	
30317	85	180	44.5	4	275 000	330 000	2 200	2 900	4.994
30317D	85	180	44.5	4	236 000	285 000	1 900	2 600	4.752
30318	90	190	46.5	4	302 000	366 000	2 100	2 700	5.774
30318D	90	190	46.5	4	254 000	302 000	1 700	2 400	5.524
30319	95	200	49.5	4	285 000	332 000	2 000	2 600	6.780
30319D	95	200	49.5	4	287 000	352 000	1 700	2 300	6.700
30320	100	215	51.5	4	310 000	360 000	1 800	2 400	8.320
30320D	100	215	51.5	4	286 000	336 600	1 500	2 100	8.920
30321	105	225	53.5	4	334 000	380 000	1 700	2 300	8.740
30321D	105	225	53.5	4	305 000	356 000	1 400	2 000	8.740
30322D	110	240	54.5	4	328 000	386 000	1 400	1 900	11.140
30322	110	240	54.5	4	432 000	530 000	1 600	2 100	11.140
30324	120	260	59.5	4	454 000	550 000	1 500	2 000	14.120
30324D	120	260	59.5	4	387 000	460 000	1 200	1 700	12.960
30326	130	280	63.75	5	506 000	615 000	1 400	1 800	17.260
30326D	130	280	63.75	5	483 000	598 000	1 200	1 600	17.260
30328	140	300	67.75	5	564 000	685 000	1 300	1 700	21.400
30328D	140	300	67.75	5	472 000	565 000	1 100	1 500	21.400
30330	150	320	72	5	645 000	865 000	1 200	1 500	24.320
30330D	150	320	72	5	554 000	675 000	970	1 400	24.320
30332	160	340	75	5	714 000	880 000	1 100	1 400	28.930
30334	170	360	80	5	745 000	918 000	1 000	1 300	34.781
30336	180	380	83	5	810 000	999 000	940	1 300	45.000
30338	190	400	86	5	909 000	1 125 000	880	1 200	46.500
30340	200	420	89	5	1 008 000	1 300 000	820	1 100	53.500
30344	220	460	97	5	1 134 000	1 500 000	730	980	69.000
30348	240	500	105	5	1 368 000	1 890 000	670	890	87.000

## Tapered Roller Bearings

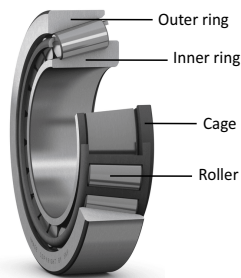
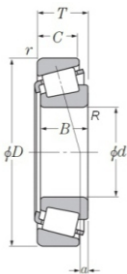

Bearing No.	Boundary dimensions(mm)			r(mm)	Cr(N)	Cor(N)	Limiting Speed (min <sup>-1</sup> )		Mass (Kg)
	d	D	B				Grease	Oil	
32004	20	42	15	0.6	24 600	28 400	9 300	13 000	0.100
32005	25	47	15	0.6	27 200	34 000	8 300	11 000	0.116
32006	30	55	17	1	34 400	43 200	7 000	9 400	0.174
32007	35	62	18	1	41 000	53 500	6 200	8 200	0.228
32008	40	68	19	1	48 200	64 300	5 600	7 400	0.276
32009	45	75	20	1	56 500	77 800	5 000	6 600	0.342
32010	50	80	20	1	59 000	85 000	4 600	6 100	0.380
32011	55	90	23	1.5	76 000	108 000	4 100	5 500	0.556
32012	60	95	23	1.5	77 500	114 000	3 900	5 200	0.596
32013	65	100	23	1.5	81 000	123 000	3 600	4 800	0.626
32014	70	110	25	1.5	97 000	146 000	3 300	4 400	0.854
32015	75	115	25	1.5	99 000	152 000	3 100	4 200	0.888
32016	80	125	29	1.5	132 000	202 000	2 900	3 900	1.276
32017	85	130	29	1.5	135 000	211 000	2 800	3 700	1.318
32018	90	140	32	2	160 000	248 000	2 600	3 500	1.740
32019	95	145	32	2	164 000	258 000	2 500	3 300	1.808
32020	100	150	32	2	167 000	268 000	2 400	3 200	1.884



Bearing No.	Boundary dimensions(mm)			r(mm)	Cr(N)	Cor(N)	Limiting Speed (min-1)		Mass (Kg)
	d	D	B				Grease	Oil	
32021	105	160	35	2.5	193 000	310 000	2 200	3 000	2.468
32022	110	170	38	2.5	223 000	355 000	2 100	2 800	3.030
32024	120	180	38	2.5	232 000	384 000	2 000	2 600	3.190
32026	130	200	45	2.5	306 000	507 000	1 800	2 300	4.998
32028	140	210	45	2.5	311 000	526 000	1 700	2 200	5.240
32030	150	225	48	3	352 000	600 000	1 500	2 000	6.360
32032	160	240	51	3	396 000	682 000	1 400	1 900	7.820
32034	170	260	57	3	473 000	815 000	1 300	1 700	10.540
32036	180	280	64	3	580 000	990 000	1 200	1 600	14.200
32038	190	290	64	3	589 000	1 050 000	1 100	1 500	15.000
32040	200	310	70	3	680 000	1 200 000	1 100	1 400	17.860
32044	220	340	76	4	805 000	1 450 000	940	1 300	25.500
32048	240	360	76	4	832 000	1 540 000	870	1 300	25.860
32052	260	400	87	5	1 053 000	1 950 000	770	1 000	40.000
32056	280	420	87	5	1 080 000	2 050 000	720	960	40.500
32060	300	460	100	5	1 287 000	2 395 000	640	850	58.000
32064	320	480	100	5	1 359 000	2 530 000	600	800	61.800

## Tapered Roller Bearings

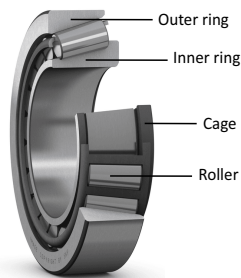
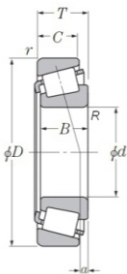

Bearing No.	Boundary dimensions(mm)			r(mm)	Cr(N)	Cor(N)	Limiting Speed (min <sup>-1</sup> )		Mass (Kg)
	d	D	B				Grease	Oil	
32204	20	47	19.25	1	29 300	31 200	8 700	12 000	0.162
32205	25	52	19.25	1	35 900	40 400	7 900	11 000	0.190
32206	30	62	21.25	1	45 700	52 100	6 500	8 700	0.288
32207	35	72	24.25	1.5	62 700	74 200	5 600	7 500	0.444
32208	40	80	24.75	1.5	70 000	81 800	5 000	6 600	0.540
32209	45	85	24.75	1.5	70 500	84 700	4 600	6 100	0.588
32210	50	90	24.75	1.5	76 500	94 500	4 300	5 700	0.638
32211	55	100	26.75	2	96 300	119 700	3 900	5 200	0.858
32212	60	110	29.75	2	119 000	150 000	3 500	4 700	1.182
32213	65	120	32.75	2	142 000	182 000	3 200	4 300	1.560
32214	70	125	33.25	2	152 000	202 000	3 100	4 100	1.668
32215	75	130	33.25	2	156 000	210 000	2 900	3 900	1.734
32216	80	140	35.25	2.5	182 000	244 000	2 700	3 600	2.154
32217	85	150	38.5	2.5	209 000	283 000	2 500	3 300	2.712
32218	90	160	42.5	2.5	237 000	325 000	2 400	3 200	3.466
32219	95	170	45.5	3	280 000	395 000	2 200	3 000	4.302
32220	100	180	49	3	312 000	445 000	2 100	2 800	5.148





Bearing No.	Boundary dimensions(mm)			r(mm)	Cr(N)	Cor(N)	Limiting Speed (min-1)		Mass (Kg)
	d	D	B				Grease	Oil	
32221	105	190	53	3	352 000	510 000	2 000	2 700	6.000
32222	110	200	56	3	394 000	576 000	1 900	2 500	7.400
32224	120	215	61.5	3	423 000	621 000	1 700	2 300	9.060
32226	130	230	67.75	4	498 000	747 000	1 600	2 200	11.620
32228	140	250	71.75	4	572 000	865 000	1 500	2 000	14.680
32230	150	270	77	4	633 000	963 000	1 300	1 800	17.100
32232	160	290	84	4	715 000	1 090 000	1 200	1 700	23.580
32234	170	310	91	5	820 000	1 349 000	1 100	1 500	28.900
32236	180	320	91	5	877 000	1 380 000	1 100	1 500	29.760
32238	190	340	97	5	981 000	1 566 000	1 000	1 400	36.700
32240	200	360	104	5	1 116 000	1 692 000	960	1 300	42.500
32244	220	400	114	5	1 070 000	1 730 000	830	1 100	60.800
32248	240	440	127	5	1 450 000	2 000 000	740	980	80.470
32252	260	480	137	6	1 584 000	2 580 000	660	880	103.958
32256	280	500	137	6	1 674 000	2 830 000	610	810	108.000
32260	300	540	149	6	2 079 000	3 654 000	570	780	140.000

# Tapered Roller Bearings

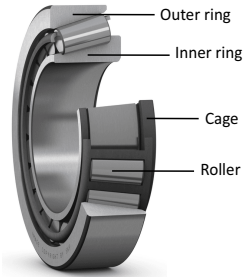
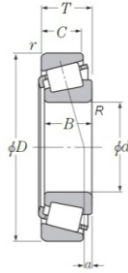

Bearing No.	Boundary dimensions(mm)			r(mm)	Cr(N)	Cor(N)	Limiting Speed (min <sup>-1</sup> )		Mass (Kg)
	d	D	B				Grease	Oil	
32303	17	47	20.25	1	28 700	26 900	9 400	13 000	0.170
32304	20	52	22.25	1.5	40 600	42 000	8 400	11 000	0.234
32305	25	62	25.25	1.5	55 000	57 700	6 900	9 100	0.370
32306	30	72	28.75	1.5	74 000	82 400	5 900	7 900	0.564
32307	35	80	32.75	2	90 000	102 600	5 300	7 000	0.762
32308	40	90	35.25	2	104 000	125 000	4 600	6 200	1.038
32309	45	100	38.25	2	131 400	162 000	4 100	5 500	1.404
32310	50	110	42.25	2.5	158 400	198 000	3 700	5 000	1.880
32311	55	120	45.5	2.5	180 000	225 000	3 400	4 500	2.392
32312	60	130	48.5	3	199 000	247 500	3 100	4 200	2.944
32313	65	140	51	3	248 000	320 000	2 900	3 900	3.534
32314	70	150	54	3	285 000	372 000	2 700	3 600	4.320
32315	75	160	58	3	326 000	433 000	2 500	3 300	5.362
32316	80	170	61.5	3	340 000	447 000	2 300	3 100	6.360
32317	85	180	63.5	4	395 000	528 000	2 200	3 000	7.280
32318	90	190	67.5	4	415 000	553 000	2 100	2 800	8.700



Bearing No.	Boundary dimensions(mm)			r(mm)	Cr(N)	Cor(N)	Limiting Speed (min-1)		Mass (Kg)
	d	D	B				Grease	Oil	
32319	95	200	71.5	4	465 000	625 000	2 000	2 600	10.080
32320	100	215	77.5	4	442 000	573 000	1 800	2 400	13.200
32321	105	225	81.5	4	572 000	750 000	1 800	2 300	14.980
32322	110	240	84.5	4	590 000	790 000	1 600	2 200	17.920
32324	120	260	90.5	4	720 000	999 000	1 500	2 000	22.360
32326	130	280	98.75	5	766 000	1 040 000	1 400	1 800	28.420
32328	140	300	107.75	5	862 000	1 180 000	1 300	1 700	35.100
32330	150	320	114	5	1 070 000	1 350 000	1 200	1 600	46.000
32332	160	340	121	5	1 100 000	1 548 000	1 100	1 400	54.000
32334	170	360	127	5	1 180 000	1 647 000	1 000	1 300	58.000
32336	180	380	134	5	1 260 000	1 782 000	960	1 300	70.000
32338	190	400	140	5	1 390 000	1 970 000	890	1 200	76.600
32340	200	420	146	5	1 600 000	2 320 000	830	1 100	90.900
32344	220	460	154	5	1 890 000	2 850 000	750	1 000	112.800
32348	240	500	165	5	2 259 000	3 480 000	670	890	130.000

## Tapered Roller Bearings

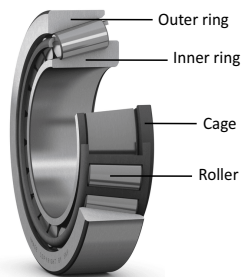
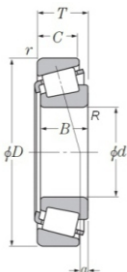

Bearing No.	Boundary dimensions(mm)			r(mm)	Cr(N)	Cor(N)	Limiting Speed (min <sup>-1</sup> )		Mass (Kg)
	d	D	B				Grease	Oil	
32907	35	55	14	0.6	23 500	32 800	6 600	8 800	0.127
32908	40	62	15	0.6	30 200	43 700	5 900	7 800	0.170
32909	45	68	15	0.6	31 200	47 200	5 300	7 100	0.196
32910	50	72	15	0.6	32 300	50 700	4 900	6 600	0.202
32911	55	80	17	1	40 000	65 900	4 400	5 900	0.300
32912	60	85	17	1	41 600	70 400	4 100	5 500	0.300
32913	65	90	17	1	42 700	74 800	3 900	5 200	0.310
32914	70	100	20	1	64 000	103 500	3 500	4 700	0.490
32915	75	105	20	1	66 000	110 000	3 300	4 400	0.550
32916	80	110	20	1	68 500	118 000	3 100	4 200	0.500
32917	85	120	23	1.5	87 400	148 000	2 900	3 900	0.700
32918	90	125	23	1.5	90 000	157 000	2 800	3 700	0.850
32919	95	130	23	1.5	93 600	167 000	2 600	3 500	0.847
32920	100	140	25	1.5	113 400	195 000	2 400	3 300	1.200
32921	105	145	25	1.5	115 200	200 000	2 400	3 100	1.150
32922	110	150	25	1.5	116 100	208 000	2 300	3 000	1.250



Bearing No.	Boundary dimensions(mm)			r(mm)	Cr(N)	Cor(N)	Limiting Speed (min-1)		Mass (Kg)
	d	D	B				Grease	Oil	
32924	120	165	29	1.5	154 800	268 000	2 100	2 700	1.700
32926	130	180	32	2	180 000	331 000	1 900	2 500	2.400
32928	140	190	32	2	185 400	350 000	1 800	2 300	2.550
32930	150	210	38	2.5	257 400	482 000	1 600	2 100	3.690
32932	160	220	38	2.5	260 000	511 000	1 500	2 000	4.190
32934	170	230	38	2.5	266 000	545 000	1 400	1 900	4.500
32936	180	250	45	2.5	321 000	660 000	1 300	1 700	6.650
32938	190	260	45	2.5	329 000	700 000	1 200	1 600	7.000
32940	200	280	51	3	438 000	862 000	1 100	1 500	9.500
32944	220	300	51	3	448 000	909 000	1 000	1 400	9.020
32948	240	320	51	3	464 000	981 000	940	1 300	10.300
32952	260	360	63.5	3	666 000	1 395 000	830	1 100	16.900
32956	280	380	63.5	3	684 000	1 467 000	770	1 000	19.900
32960	300	420	76	4	945 000	1 989 000	680	910	31.300
32964	320	440	76	4	954 000	2 045 000	640	850	33.500

## Tapered Roller Bearings

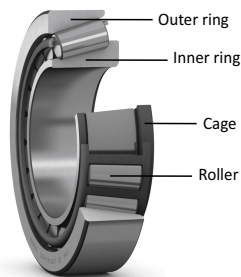
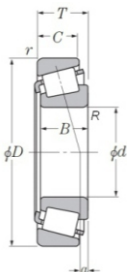

Bearing No.	Boundary dimensions(mm)			r(mm)	Cr(N)	Cor(N)	Limiting Speed (min-1)		Mass (Kg)
	d	D	B				Grease	Oil	
33005	25	47	17	0.6	30 200	38 000	8 300	11 000	0.132
33006	30	55	20	1	38 900	49 700	7 000	9 400	0.200
33007	35	62	21	1	46 200	61 200	6 200	8 200	0.264
33008	40	68	22	1	54 400	76 200	5 500	7 400	0.330
33009	45	75	24	1	62 700	90 900	5 000	6 700	0.426
33010	50	80	24	1	66 000	99 000	4 600	6 100	0.448
33011	55	90	27	1.5	86 900	134 000	4 100	5 400	0.638
33012	60	95	27	1.5	91 000	145 000	3 900	5 200	0.674
33013	65	100	27	1.5	93 000	152 000	3 600	4 800	0.720
33014	70	110	31	1.5	120 600	187 000	3 300	4 400	1.100
33015	75	115	31	1.5	126 900	202 000	3 000	4 100	1.166
33016	80	125	36	1.5	155 700	259 000	2 900	3 900	1.622
33017	85	130	36	1.5	159 300	270 000	2 800	3 700	1.660
33018	90	140	39	2	198 000	330 000	2 600	3 400	2.198
33019	95	145	39	2	203 000	343 000	2 500	3 300	2.278
33020	100	150	39	2	208 000	357 000	2 400	3 200	2.346
33021	105	160	43	2.5	240 000	415 000	2 200	3 000	3.050
33022	110	170	47	2.5	258 000	452 000	2 100	2 800	3.742
33024	120	180	48	2.5	269 000	486 000	2 000	2 600	4.070
33026	130	200	55	2.5	350 000	634 000	1 700	2 300	5.860
33028	140	210	56	2.5	365 000	682 000	1 600	2 200	6.570



Bearing No.	Boundary dimensions(mm)			r(mm)	Cr(N)	Cor(N)	Limiting Speed (min-1)		Mass (Kg)
	d	D	B				Grease	Oil	
33108	40	75	26	1.5	74 000	97 200	5 200	6 900	0.493
33109	45	80	26	1.5	78 800	108 000	4 800	6 400	0.530
33110	50	85	26	1.5	80 500	114 300	4 400	5 900	0.578
33111	55	95	30	1.5	104 400	145 000	4 000	5 300	0.854
33112	60	100	30	1.5	106 200	153 000	3 600	4 900	0.920
33113	65	110	34	1.5	136 800	200 000	3 400	4 600	1.268
33114	70	120	37	2	154 800	225 000	3 200	4 300	1.650
33115	75	125	37	2	168 000	252 000	3 000	4 000	1.810
33116	80	130	37	2	172 000	265 000	2 800	3 800	1.880
33117	85	140	41	2.5	200 000	311 000	2 600	3 500	2.404
33118	90	150	45	2.5	225 000	351 000	2 400	3 200	3.146
33120	100	165	52	2.5	292 000	470 000	2 200	3 000	4.140
33122	110	180	56	2.5	332 000	570 000	2 000	2 700	5.550
33124	120	200	62	2.5	415 000	706 000	1 800	2 400	7.510

## Tapered Roller Bearings

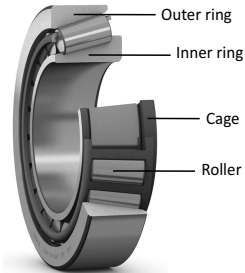
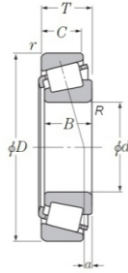

Bearing No.	Boundary dimensions(mm)			r(mm)	Cr(N)	Cor(N)	Limiting Speed (min <sup>-1</sup> )		Mass (Kg)
	d	D	B				Grease	Oil	
33205	25	52	22	1	44 000	52 700	7 900	10 000	0.226
33206	30	62	25	1	59 800	71 500	6 500	8 700	0.340
33207	35	72	28	1.5	78 000	96 300	5 700	7 500	0.526
33208	40	80	32	1.5	97 200	125 100	5 000	6 700	0.706
33209	45	85	32	1.5	100 000	134 100	4 600	6 200	0.762
33210	50	90	32	1.5	108 000	150 300	4 300	5 700	0.838
33211	55	100	35	2	128 000	170 000	3 900	5 200	1.167
33212	60	110	38	2	156 000	215 000	3 600	4 700	1.484
33213	65	120	41	2	180 000	249 000	3 200	4 300	1.942
33214	70	125	41	2	185 000	264 000	3 100	4 100	2.066
33215	75	130	41	2	190 000	279 000	2 900	3 900	2.188
33216	80	140	46	2.5	225 000	333 000	2 700	3 600	2.842
33217	85	150	49	2.5	264 000	395 000	2 500	3 400	3.454
33218	90	160	55	2.5	300 000	459 000	2 400	3 200	4.760
33219	95	170	58	3	337 000	523 000	2 200	2 900	6.350
33220	100	180	63	3	388 000	612 000	2 100	2 800	6.700





Bearing No.	Boundary dimensions(mm)			r(mm)	Cr(N)	Cor(N)	Limiting Speed (min-1)		Mass (Kg)
	d	D	B				Grease	Oil	
02474/02420	28.575	68.263	22.225	0.8	45 900	55 000	6 000	8 000	0.406
02475/02420	31.750	68.263	22.225	3.6	45 900	55 000	6 000	8 000	0.370
02872/02820	28.575	73.025	22.225	0.8	49 500	59 200	5 500	7 400	0.492
09067/09195	19.050	49.225	18.034	1.2	33 900	34 000	8 900	12 000	0.204
11162/11300	41.275	76.200	18.009	1.6	46 500	57 000	5 200	6 900	0.341
11590/11520	15.875	42.863	14.288	1.6	16 000	16 000	10 000	14 000	0.106
1280/1220	22.225	57.150	22.225	0.8	47 400	50 000	7 600	10 000	22.225
13686/13621	38.100	69.012	26.195	1.6	44 300	55 800	5 600	7 500	0.356
1380/1328	22.225	52.388	19.368	1.6	33 000	34 200	8 000	11 000	0.198
14116/14276	30.226	69.012	19.845	0.8	41 500	50 000	5 900	7 800	0.370
14118/14283	30.000	72.085	22.385	0.8	41 500	50 000	5 900	7 800	0.434
14125A/14274	31.750	69.012	19.845	3.6	41 500	50 000	5 900	7 800	0.344
14125A/14276	31.750	69.012	19.845	3.6	41 500	50 000	5 900	7 800	0.347
14130/14274	33.338	69.012	19.845	3.6	41 500	50 000	5 900	7 800	0.331
14130/14276	33.338	69.012	19.845	3.6	41 500	50 000	5 900	7 800	0.334
14131/14274	33.338	69.012	19.845	0.8	41 500	50 000	5 900	7 800	0.334
14131/14276	33.338	69.012	19.845	0.8	41 500	50 000	5 900	7 800	0.337
14137A/14274	34.925	69.012	19.845	1.6	41 500	50 000	5 900	7 800	0.321
14137A/14276	34.925	69.012	19.845	1.6	41 500	50 000	5 900	7 800	0.323
14138A/14274	34.925	69.012	19.845	3.6	41 500	50 000	5 900	7 800	0.318
14138A/14276	34.925	69.012	19.845	3.6	41 500	50 000	5 900	7 800	0.334
15100/15245	25.400	61.999	19.050	3.6	40 200	45 700	6 400	8 600	0.290
15101/15245	25.400	61.999	19.050	0.8	40 200	45 700	6 400	8 600	0.295
15103/15243	26.157	61.913	19.050	0.8	40 200	45 700	6 400	8 600	0.296
15103/15245	26.157	61.999	19.050	0.8	40 200	45 700	6 400	8 600	0.294
15106/15245	26.988	61.999	19.050	0.8	40 200	45 700	6 400	8 600	0.280
15106/15250	26.988	63.500	20.638	0.8	40 200	45 700	6 400	8 600	0.310
15106/15250X	26.988	63.500	20.638	0.8	40 200	45 700	6 400	8 600	0.310
15112/15245	28.575	61.999	19.050	3.6	40 200	45 700	6 400	8 600	0.274
15112/15250	28.575	63.500	20.638	3.6	40 200	45 700	6 400	8 600	0.370
15117/15245	29.987	61.999	19.050	1.2	40 200	45 700	6 400	8 600	0.278
15118/15245	30.213	61.999	19.050	3.6	40 200	45 700	6 400	8 600	0.262
15118/15250	30.213	63.500	20.638	3.6	40 200	45 700	6 400	8 600	0.293

## Tapered Roller Bearings

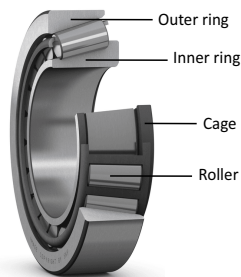
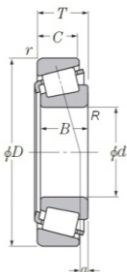

Bearing No.	Boundary dimensions(mm)			r(mm)	Cr(N)	Cor(N)	Limiting Speed (min <sup>-1</sup> )		Mass (Kg)
	d	D	B				Grease	Oil	
15118/15250X	30.213	63.500	20.638	3.6	40 200	45 700	6 400	8 600	0.292
15120/15245	30.213	61.999	19.050	0.8	40 200	45 700	6 400	8 600	0.264
15123/15245	31.750	61.999	18.161	SP	40 200	45 700	6 400	8 600	0.230
15125/15245	31.750	61.999	19.050	3.6	40 200	45 700	6 400	8 600	0.240
15126/15245	31.750	61.999	19.050	0.8	40 200	45 700	6 400	8 600	0.252
1755/1729	22.225	56.896	19.368	1.2	36 000	38 800	7 600	10 000	0.265
1779/1729	23.812	56.896	19.368	0.8	36 000	38 800	7 600	10 000	0.241
17887/17831	45.230	79.985	19.842	2	49 600	63 800	4 800	6 400	0.410
18590/18520	41.275	73.025	16.667	3.6	42 400	50 200	5 200	6 900	0.272
18690/18620	46.038	79.375	17.463	2.8	42 400	53 200	4 800	6 400	0.329
18790/18720	50.800	85.001	17.463	3.6	44 800	59 000	4 400	5 900	0.367
19150/19268X	38.100	68.275	20.000	1.6	41 500	48 500	5 700	7 600	0.276
1988/1922	28.575	57.150	19.845	3.6	44 000	51 400	7 000	9 300	0.220
21075/21212	19.050	53.975	22.225	1.57	37 800	37 000	8 400	11 000	0.254
23100/23256	25.400	65.088	22.225	1.6	43 000	46 600	5 600	7 900	0.356
24780/24720	41.275	76.200	22.225	3.6	59 700	75 000	5 200	6 900	0.432
24780/24721	41.275	76.200	25.400	3.6	59 700	75 000	5 200	6 900	0.432
25577/25522	42.875	83.058	23.876	3.6	69 600	90 000	4 800	6 300	0.610
25577/25523	42.875	82.931	26.988	3.6	69 600	90 000	4 800	6 300	0.610
25580/25520	44.450	82.931	23.813	3.6	69 600	90 000	4 800	6 300	0.554
25580/25522	44.450	83.058	23.876	3.6	69 600	90 000	4 800	6 300	0.565
25581/25520	44.450	82.931	23.813	0.5	69 600	90 000	4 800	6 300	0.565
25584/25520	44.983	82.931	23.813	1.6	69 600	90 000	4 800	6 300	0.552
25584/25521	44.983	83.058	23.813	1.6	69 600	90 000	4 800	6 300	0.540
25584/25522	44.983	83.058	23.876	1.6	69 600	90 000	4 800	6 300	0.560
25590/25520	45.618	82.931	23.813	3.6	69 600	90 000	4 800	6 300	0.532
25590/25521	45.618	83.058	23.813	3.6	69 600	90 000	4 800	6 300	0.545
25590/25522	45.618	83.058	23.876	3.6	69 600	90 000	4 800	6 300	0.520
25590/25523	45.618	82.931	26.988	3.6	69 600	90 000	4 800	6 300	0.570
2580/2520	31.750	66.421	25.400	0.8	64 300	77 000	6 000	8 000	0.404
2580/2523	31.750	69.850	23.813	0.8	64 300	77 000	6 000	8 000	0.451
25877/25820	34.925	73.025	23.813	1.6	65 000	78 600	5 600	7 400	0.474
25877/25821	34.925	73.025	23.813	1.6	65 000	78 600	5 600	7 400	0.472



Bearing No.	Boundary dimensions(mm)			r(mm)	Cr(N)	Cor(N)	Limiting Speed (min-1)		Mass (Kg)
	d	D	B				Grease	Oil	
25880/25820	36.487	73.025	23.813	1.6	65 000	78 600	5 600	7 400	0.470
25880/25821	36.487	73.025	23.813	1.6	65 000	78 600	5 600	7 400	0.459
26878/26820	38.100	80.167	25.400	0.8	73 000	94 500	5 000	6 700	0.614
26878/26822	38.100	79.375	23.813	0.8	73 000	94 500	5 000	6 700	0.570
26882/26820	41.275	80.167	25.400	3.6	73 000	94 500	5 000	6 700	0.532
26882/26822	41.275	79.375	23.813	3.6	73 000	94 500	5 000	6 700	0.520
27687/27620	82.550	125.413	25.400	3.6	91 000	145 800	2 900	3 800	1.040
27690/27620	83.345	125.413	25.400	3.6	91 000	145 800	2 900	3 800	1.020
27695/27620	84.975	125.413	25.400	5	91 000	145 800	2 900	3 800	0.988
2780/2720	36.487	76.200	23.813	1.6	66 700	83 000	5 400	7 200	0.524
2788/2720	38.100	76.200	23.813	3.6	66 700	83 000	5 400	7 200	0.492
2789/2720	39.688	76.200	23.813	3.6	66 700	83 000	5 400	7 200	0.417
2789/2729	39.688	76.200	23.813	3.6	66 700	83 000	5 400	7 200	0.477
2790/2720	33.338	76.200	23.813	1.6	66 700	83 000	5 400	7 200	0.548
28158/28300	40.000	76.200	20.638	1.6	51 600	59 400	5 300	7 000	0.402
28580./28521	50.800	92.075	24.608	3.6	76 400	107 000	4 200	5 600	0.702
28580/28520	50.800	89.980	24.750	3.6	76 400	107 000	4 200	5 600	0.656
28584./28521	52.388	92.075	24.608	3.6	76 400	107 000	4 200	5 600	0.672
28678/28622	50.800	97.630	24.608	3.6	80 700	107 000	3 900	5 200	0.836
28680/28622	55.563	97.630	24.608	3.6	80 700	107 000	3 900	5 200	0.766
28682/28621	57.150	96.838	24.608	3.6	80 700	107 000	3 900	5 200	0.715
28682/28622	57.150	97.630	24.608	3.6	80 700	107 000	3 900	5 200	0.730
28985/28920	60.325	101.600	25.400	3.6	82 300	123 000	3 700	4 900	0.808
28985/28921	60.325	100.000	25.400	3.6	82 300	123 000	3 700	4 900	0.766
28985/28921A	60.325	100.000	25.400	3.6	82 300	123 000	3 700	4 900	0.768
29585/29520	63.500	107.950	25.400	3.6	83 600	128 700	3 400	4 500	0.934
29585/29521	63.500	110.000	25.400	3.6	83 600	128 700	3 400	4 500	0.763
29586/29522	63.500	107.950	25.400	1.6	83 600	128 700	3 400	4 500	0.941
29590/29520	66.675	107.950	25.400	3.6	83 600	128 700	3 400	4 500	0.850
29590/29521	66.675	110.000	25.400	3.6	83 600	128 700	3 400	4 500	0.850
29590/29522	66.675	107.950	25.400	3.6	83 600	128 700	3 400	4 500	0.861
29675/29620	69.850	112.713	25.400	1.6	83 600	139 500	3 200	4 300	0.960
29685/29620	73.025	112.713	25.400	3.6	83 600	139 500	3 200	4 300	0.890

## Tapered Roller Bearings

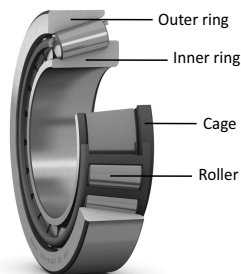
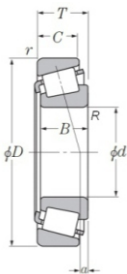

Bearing No.	Boundary dimensions(mm)			r(mm)	Cr(N)	Cor(N)	Limiting Speed (min <sup>-1</sup> )		Mass (Kg)
	d	D	B				Grease	Oil	
31593/31520	34.925	76.200	29.370	3.6	72 900	88 000	5 400	7 200	0.620
31594/31520	34.925	76.200	29.370	1.6	72 900	88 000	5 400	7 200	0.640
31597/31520	36.513	76.200	29.370	3.6	72 900	88 000	5 400	7 200	0.760
33262/33462	66.675	117.475	30.163	3.6	106 200	160 000	3 200	4 200	1.350
33275/33462	69.850	117.475	30.163	3.6	106 200	160 000	3 200	4 200	1.300
33275/33472	69.850	120.000	29.794	3.6	106 200	160 000	3 200	4 200	1.340
33281/33462	71.438	117.475	30.163	3.6	106 200	160 000	3 200	4 200	1.214
33281/33472	71.438	120.000	29.794	3.6	106 200	160 000	3 200	4 200	1.350
33287/33462	73.025	117.475	30.163	3.6	106 200	160 000	3 200	4 200	1.200
33287/33472	73.025	120.000	29.794	3.6	106 200	160 000	3 200	4 200	1.183
3379/3320	34.925	80.167	29.370	3.6	81 900	95 400	5 000	6 700	0.720
3383/3320	41.275	80.167	29.370	3.6	81 900	95 400	5 000	6 700	0.636
3384/3320	41.275	80.167	29.370	0.8	81 900	95 400	5 000	6 700	0.640
33885/33822	44.450	95.250	27.783	0.8	97 200	127 000	4 100	5 400	1.040
33889/33821	50.800	95.250	27.783	3.6	97 200	127 000	4 100	5 400	0.868
33889/33822	50.800	95.250	27.783	3.6	97 200	127 000	4 100	5 400	0.871
33890/33821	52.388	95.250	27.783	1.6	97 200	127 000	4 100	5 400	0.845
33891/33821	52.388	95.250	27.783	3.6	97 200	127 000	4 100	5 400	0.842
33895/33821	53.975	95.250	27.783	1.6	97 200	127 000	4 100	5 400	0.790
33895/33822	53.975	95.250	27.783	1.6	97 200	127 000	4 100	5 400	0.800
34300/34478	76.200	121.442	24.608	2	81 000	114 000	3 000	4 000	0.980
34300/34500	76.200	127.000	26.988	2	81 000	114 000	3 000	4 000	1.158
3478/3420	34.925	79.375	29.370	3.6	78 700	94 500	5 200	6 900	0.718
3490/3420	38.100	79.375	29.370	3.6	78 700	94 500	5 200	6 900	0.652
355X/352	44.450	90.119	23.000	3.6	64 700	73 600	4 600	6 200	0.670
355X/354A	44.450	85.001	20.638	3.6	64 700	73 600	4 600	6 200	0.502
3577/3520	41.275	84.138	30.163	3.6	86 300	108 000	4 600	6 200	0.800
3577/3525	41.275	87.313	30.163	3.6	86 300	108 000	4 600	6 200	0.830
3578/3520	44.450	84.138	30.163	3.6	86 300	108 000	4 600	6 200	0.760
3578/3525	44.450	87.313	30.163	3.6	86 300	108 000	4 600	6 200	0.762
3579/3525	42.863	87.313	30.163	3.6	86 300	108 000	4 600	6 200	0.806
3585/3525	41.275	87.313	30.163	1.6	86 300	108 000	4 600	6 200	0.830
3586/3520	45.237	84.138	30.163	3.6	86 300	108 000	4 600	6 200	0.688



Bearing No.	Boundary dimensions(mm)			r(mm)	Cr(N)	Cor(N)	Limiting Speed (min-1)		Mass (Kg)
	d	D	B				Grease	Oil	
3586/3525	45.237	87.313	30.163	3.6	86 300	108 000	4 600	6 200	0.783
359S/354A	46.038	85.001	20.638	2.4	64 700	73 600	4 600	6 200	0.483
36686/36620	142.875	193.675	28.575	1.6	168 300	337 500	1 700	2 300	2.425
36690/36620	146.050	193.675	28.575	1.6	168 300	337 500	1 700	2 300	2.300
368A/362	50.800	90.000	20.000	3.6	67 000	78 600	4 400	5 800	0.500
368A/362A	50.800	88.900	20.638	3.6	67 000	78 600	4 400	5 800	0.505
368S/362	51.592	90.000	20.000	2	67 000	78 600	4 400	5 800	0.495
369A/362	47.625	90.000	20.000	3.6	67 000	78 600	4 400	5 800	0.546
369S/362A	47.625	88.900	20.638	2.4	67 000	78 600	4 400	5 800	0.560
37425/37625	107.950	158.750	23.020	3.6	93 600	152 000	2 000	3 000	1.370
3767/3720	52.388	93.264	30.163	2.4	92 700	123 300	4 200	5 500	0.807
3775/3720	50.800	93.264	30.163	0.8	92 700	123 300	4 200	5 500	0.839
3776/3720	44.983	93.264	30.163	3.6	92 700	123 300	4 200	5 500	0.938
3779/3720	47.625	93.264	30.163	3.6	92 700	123 300	4 200	5 500	0.900
3780/3720	50.800	93.264	30.163	3.6	92 700	123 300	4 200	5 500	0.826
3782/3720	44.450	93.264	30.163	3.6	92 700	123 300	4 200	5 500	0.950
387/382	57.150	98.425	21.001	2.4	72 400	91 000	3 900	5 200	0.630
387/382A	57.150	96.838	21.001	2.4	72 400	91 000	3 900	5 200	0.605
387/382S	57.150	96.838	25.400	2.4	72 400	91 000	3 900	5 200	0.605
3872/3820	34.925	85.725	30.162	3.6	97 200	122 400	4 800	6 400	0.920
3877/3820	41.275	85.725	30.162	3.6	97 200	122 400	4 800	6 400	0.830
387A/382	57.150	98.425	21.001	3.6	72 400	91 000	3 900	5 200	0.620
387A/382A	57.150	96.838	21.001	3.6	72 400	91 000	3 900	5 200	0.598
387A/382S	57.150	96.838	25.400	3.6	72 400	91 000	3 900	5 200	0.574
387AS/382A	57.150	96.838	21.001	5	72 400	91 000	3 900	5 200	0.599
387AS/382S	57.150	96.838	25.400	5	72 400	91 000	3 900	5 200	0.597
388A/382	57.531	98.425	21.001	3.6	72 400	91 000	3 900	5 200	0.644
389A/382	53.975	98.425	21.001	0.8	72 400	91 000	3 900	5 200	0.680
389AS/382A	53.975	96.838	21.001	1.6	72 400	91 000	3 900	5 200	0.656
390/394A	57.150	110.000	21.999	2.4	77 800	104 400	3 400	4 500	0.962
390A/394A	63.500	110.000	21.999	1.6	77 800	104 400	3 400	4 500	0.854
392/394A	61.913	110.000	21.999	0.8	77 800	104 400	3 400	4 500	0.900
395/394A	63.500	110.000	21.999	3.6	77 800	104 400	3 400	4 500	0.846

## Tapered Roller Bearings

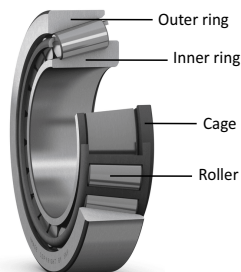
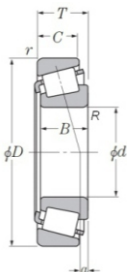

Bearing No.	Boundary dimensions(mm)			r(mm)	Cr(N)	Cor(N)	Limiting Speed (min <sup>-1</sup> )		Mass (Kg)
	d	D	B				Grease	Oil	
39580/39520	57.150	112.713	30.163	3.6	132 300	186 300	3 300	4 500	1.388
39581/39520	57.150	112.713	30.163	7.9	132 300	186 300	3 300	4 500	1.375
39585/39520	63.500	112.713	30.163	3.6	132 300	186 300	3 300	4 500	1.214
39590/39520	66.675	112.713	30.163	3.6	132 300	186 300	3 300	4 500	1.172
395A/394A	66.675	110.000	21.999	0.8	77 800	104 400	3 400	4 500	0.782
395S/394A	66.675	110.000	21.999	3.6	77 800	104 400	3 400	4 500	0.796
3980/3920	60.325	112.713	30.163	3.6	100 000	147 600	3 400	4 500	1.290
3982/3920	63.500	112.713	30.163	3.6	100 000	147 600	3 400	4 500	1.222
3984/3920	66.675	112.713	30.163	3.6	100 000	147 600	3 400	4 500	1.162
3994/3920	66.675	112.713	30.163	5.6	100 000	147 600	3 400	4 500	1.140
399A/394A	68.263	110.000	21.999	2.4	77 800	104 400	3 400	4 500	0.760
399AS/394A	68.263	110.000	21.999	5.2	77 800	104 400	3 400	4 500	0.744
418/414	38.100	88.501	26.988	3.6	88 400	100 800	4 900	6 500	0.822
42368/42584	93.663	148.430	28.575	3	128 700	202 500	2 400	3 200	1.780
42376/42587	95.250	149.225	31.750	3.6	128 700	202 500	2 400	3 200	1.852
42381/42584	96.838	148.430	28.575	3.6	128 700	202 500	2 400	3 200	1.720
42688/42620	76.200	127.000	30.163	6.4	128 700	202 500	2 400	3 200	1.474
42690/42620	77.788	127.000	30.163	3.6	127 800	188 100	2 400	3 200	1.380
4388/4335	41.275	90.488	39.688	3.6	118 800	152 100	4 500	6 000	1.250
45280/45220	44.450	104.775	30.163	0.8	113 400	148 500	3 700	4 900	1.194
45284/45220	50.800	104.775	30.163	6.4	113 400	148 500	3 700	4 900	1.198
45289/45220	57.150	104.775	30.163	0.8	113 400	148 500	3 700	4 900	1.100
45290/45220	57.150	104.775	30.163	2.4	113 400	148 500	3 700	4 900	1.100
45290/45221	57.150	104.775	30.163	2.4	113 400	148 500	3 700	4 900	1.105
46143/46368	36.513	93.663	31.750	1.6	94 500	120 600	4 400	5 800	1.150
462/453X	57.150	104.775	30.163	2.4	98 100	129 600	3 700	4 900	1.038
46780/46720	158.750	225.425	41.275	3.6	232 200	511 200	1 400	1 900	5.160
469/453X	57.150	104.775	30.163	3.6	98 100	129 600	3 700	4 900	1.014
47487/47420	69.850	120.000	32.545	3.6	135 000	196 200	3 100	4 200	1.460
47490/47420	71.438	120.000	32.545	3.6	135 000	196 200	3 100	4 200	1.410
47678/47620	76.200	133.350	33.338	6.4	130 500	203 400	2 700	3 700	1.870
47679/47620	76.200	133.350	33.338	3.6	130 500	203 400	2 700	3 700	1.900
47686/47620	82.550	133.350	33.338	3.6	130 500	203 400	2 700	3 700	1.742



Bearing No.	Boundary dimensions(mm)			r(mm)	Cr(N)	Cor(N)	Limiting Speed (min-1)		Mass (Kg)
	d	D	B				Grease	Oil	
47687/47620	82.550	133.350	33.338	6.7	130 500	203 400	2 700	3 700	1.660
47890/47820	92.075	146.050	33.338	3.6	160 200	263 700	2 500	3 300	2.120
47896/47820	95.250	146.050	33.338	3.6	160 200	263 700	2 500	3 300	1.930
480/472	68.263	120.000	29.794	3.6	106 200	144 900	3 200	4 200	1.350
482/472	69.850	120.000	29.794	3.6	106 200	144 900	3 200	4 200	1.300
48286/48220	123.825	182.563	39.688	3.6	204 300	386 100	1 900	2 500	3.490
48290/48220	127.000	182.563	39.688	3.6	204 300	386 100	1 700	2 300	3.300
48393/48320	136.525	190.500	39.688	3.6	212 400	424 800	1 800	2 400	3.425
484/472	70.000	120.000	29.794	2	106 200	144 900	3 200	4 200	1.306
48685/48620	142.875	200.025	41.275	3.6	221 400	441 900	1 700	2 200	3.840
495/492A	82.550	133.350	30.163	3.6	119 700	178 200	2 700	3 600	1.509
495/493	82.550	136.525	30.163	3.6	119 700	178 200	2 700	3 600	1.610
49585/49520	50.800	101.600	31.750	3.6	102 600	128 700	3 900	5 200	1.110
495A/493	76.200	136.525	30.163	3.6	119 700	178 200	2 700	3 600	1.800
495AX/493	76.200	136.525	30.163	6.4	119 700	178 200	2 700	3 600	1.794
496/493	80.963	136.525	30.163	3.6	119 700	178 200	2 700	3 600	1.660
497/492A	85.725	133.350	30.163	3.6	119 700	178 200	2 700	3 600	1.450
497/493	85.725	136.525	30.163	3.6	119 700	178 200	2 700	3 600	1.522
498/493	84.138	136.525	30.163	3.6	119 700	178 200	2 700	3 600	1.574
52393/52618	100.013	157.163	36.513	3.6	162 000	259 200	2 300	3 000	2.470
52400/52618	101.600	157.163	36.513	3.6	162 000	259 200	2 300	3 000	2.364
529/522	50.800	101.600	34.925	0.8	117 900	143 100	4 000	5 300	1.260
529X/522	50.800	101.600	34.925	3.6	117 900	143 100	4 000	5 300	1.220
53176/53375	44.450	95.250	30.958	1.2	80 000	88 560	3 700	5 200	0.940
53177/53375	44.450	95.250	30.958	3.6	80 000	88. 560	3 700	5 200	0.920
536/532X	47.625	107.950	36.513	3.6	124 200	154 800	3 800	5 100	1.620
537/532X	50.800	107.950	36.513	3.6	124 200	154 800	3 800	5 100	1.520
539/532X	53.975	107.950	36.513	3.6	124 200	154 800	3 800	5 100	1.440
55175C/55437	44.450	111.125	30.163	3.6	99 900	135 000	3 100	4 300	1.445
555S/552A	57.150	123.825	38.100	3.6	145 800	200 700	3 200	4 200	2.220
557A/552A	60.325	123.825	38.100	7.9	145 800	200 700	3 200	4 200	2.100
557S/552A	53.975	123.825	38.100	3.6	145 800	200 700	3 200	4 200	2.226
559/552A	63.500	123.825	38.100	3.6	145 800	200 700	3 200	4 200	2.030

## Tapered Roller Bearings

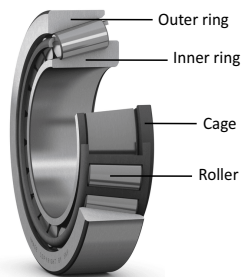
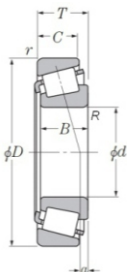

Bearing No.	Boundary dimensions(mm)			r(mm)	Cr(N)	Cor(N)	Limiting Speed (min-1)		Mass (Kg)
	d	D	B				Grease	Oil	
560/552A	66.675	123.825	38.100	3.6	145 800	200 700	3 200	4 200	1.886
560S/552A	68.263	123.825	38.100	3.6	145 800	200 700	3 200	4 200	1.846
5642S/56650	107.950	165.100	36.513	3.6	175 500	292 500	2 200	2 900	2.620
5642S/56662	107.950	168.275	36.513	3.6	175 500	292 500	2 200	2 900	2.790
566/563	69.850	127.000	36.513	3.6	140 400	203 400	3 000	4 000	1.890
567/563	73.025	127.000	36.513	3.6	140 400	203 400	3 000	4 000	1.790
575/572	76.200	139.992	36.513	3.6	157 500	235 800	2 700	3 600	2.420
576/572	73.025	139.992	36.513	3.6	157 500	235 800	2 700	3 600	2.470
5760/5735	76.200	135.733	44.450	3.6	191 700	303 300	2 800	3 700	2.727
580/572	82.550	139.992	36.513	3.6	157 500	235 800	2 700	3 600	2.640
593/592	88.900	152.400	39.688	3.6	164 700	258 300	2 400	3 300	2.810
593/592A	88.900	152.400	39.688	3.6	164 700	258 300	2 400	3 300	2.750
593A/592A	88.900	152.400	39.688	6.4	164 700	258 300	2 400	3 300	2.740
594/592	95.250	152.400	39.688	3.6	164 700	258 300	2 400	3 300	2.480
594/592A	95.250	152.400	39.688	3.6	164 700	258 300	2 400	3 300	2.480
594/593X	95.250	150.000	35.992	3.6	164 700	258 300	2 400	3 300	2.244
594A/592A	95.250	152.400	39.688	3.6	164 700	258 300	2 400	3 300	2.470
596/592A	85.725	152.400	39.688	3.6	164 700	258 300	2 400	3 300	2.900
598/592	92.075	152.400	39.688	3.6	164 700	258 300	2 400	3 300	2.680
598/592A	92.075	152.400	39.688	3.6	164 700	258 300	2 400	3 300	2.580
598/593X	92.075	150.000	35.992	3.6	164 700	258 300	2 400	3 300	2.630
598A/592A	92.075	152.400	39.688	6.4	164 700	258 300	2 400	3 300	2.640
598A/593X	92.075	150.000	35.992	6.4	164 700	258 300	2 400	3 300	2.570
598AU/592AU	92.075	152.400	39.688	6.4	164 700	258 300	2 400	3 300	2.610
623/612	57.150	120.650	41.275	3.6	156 600	195 300	3 500	4 600	2.100
6379/6320	65.088	135.755	53.975	3.6	239 400	321 300	3 000	4 000	3.610
6381/6320	54.991	135.755	53.975	3.6	239 400	321 300	3 000	4 000	4.120
6386/6320	66.675	135.755	53.975	4.3	239 400	321 300	3 000	4 000	3.640
639/632	63.500	136.525	41.275	3.6	177 300	240 300	3 000	3 900	2.780
641/632	66.675	136.525	41.275	3.6	177 300	240 300	3 000	3 900	2.670
643/632	69.850	136.525	41.275	3.6	177 300	240 300	3 000	3 900	2.560
645/632	71.438	136.525	41.275	6.4	177 300	240 300	3 000	3 900	2.550
65237/65500	60.325	127.000	44.450	3.6	187 200	242 100	3 300	4 400	2.590





Bearing No.	Boundary dimensions(mm)			r(mm)	Cr(N)	Cor(N)	Limiting Speed (min-1)		Mass (Kg)
	d	D	B				Grease	Oil	
65385/65320	44.450	114.300	44.450	3.6	170 100	207 000	3 800	5 000	2.310
6580/6535	88.900	161.925	53.975	3.6	284 400	423 900	2 400	3 200	4.820
6581X/6535	90.000	161.925	53.975	3	284 400	423 900	2 400	3 200	4.600
659/652	76.200	152.400	41.275	3.6	187 200	270 900	2 600	3 400	3.410
659/653	76.200	146.050	41.275	3.6	187 200	270 900	2 600	3 400	3.040
66225/66462	57.150	117.475	33.338	3.6	116 100	136 800	3 500	4 600	1.540
663/652	82.550	152.400	41.275	3.6	187 200	270 900	2 600	3 400	3.160
663/653	82.550	146.050	41.275	3.6	187 200	270 900	2 600	3 400	2.780
664/652	84.138	152.400	41.275	3.6	187 200	270 900	2 600	3 400	3.090
665/653	85.725	146.050	41.275	3.6	187 200	270 900	2 600	3 400	2.610
665A/653	85.725	146.050	41.275	6.4	187 200	270 900	2 600	3 400	2.640
67388/67322	127.000	196.850	46.038	3.6	279 900	504 900	1 700	2 300	5.220
67390/67322	133.350	196.850	46.038	3.6	279 900	504 900	1 700	2 300	4.650
67780/67720	165.100	247.650	47.625	3.6	311 400	630 900	1 300	1 800	7.960
67782/67720	168.275	247.650	47.625	3.6	311 400	630 900	1 300	1 800	7.650
67790/67720	177.800	247.650	47.625	3.6	311 400	630 900	1 300	1 800	6.640
67883/67820	184.150	266.700	47.625	3.6	305 100	632 700	1 200	1 600	8.590
67884/67820	187.325	266.700	47.625	3.6	305 100	632 700	1 200	1 600	8.290
681/672	92.075	168.275	41.275	3.6	201 600	314 100	2 200	3 000	3.830
683/672	95.250	168.275	41.275	3.6	201 600	314 100	2 200	3 000	3.710
68462/68712	117.475	180.975	34.925	3.6	153 900	222 300	2 000	2 700	2.760
71412/71750	104.775	190.500	47.625	3.6	272 700	434 700	1 900	2 600	5.680
71450/71750	114.300	190.500	47.625	3.6	272 700	434 700	1 900	2 600	5.050
71455/71750	115.087	190.500	47.625	7.9	272 700	434 700	1 900	2 600	4.970
740/742	80.963	150.089	44.450	5.2	237 600	331 200	2 500	3 400	3.500
74500/74850	127.000	215.900	47.625	3.6	289 800	494 100	1 600	2 200	6.850
74525/74850	133.350	215.900	47.625	3.6	289 800	494 100	1 600	2 200	6.370
749A/742	82.550	150.089	44.450	3.6	237 600	331 200	2 500	3 400	3.350
755/752	76.200	161.925	47.625	3.6	245 700	351 900	2 400	3 200	4.680
758/752	85.725	161.925	47.625	3.6	245 700	351 900	2 400	3 200	4.340
759/752	88.900	161.925	47.625	3.6	245 700	351 900	2 400	3 200	4.060
760/752	90.488	161.925	47.625	3.6	245 700	351 900	2 400	3 200	4.010
780/772	101.600	180.975	47.625	3.6	259 200	394 200	2 100	2 800	5.020

# Tapered Roller Bearings

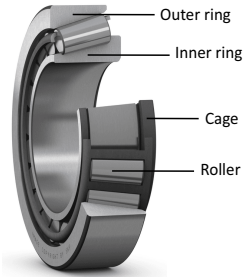
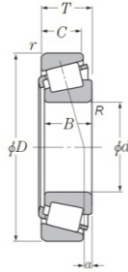

Bearing No.	Boundary dimensions(mm)			r(mm)	Cr(N)	Cor(N)	Limiting Speed (min-1)		Mass (Kg)
	d	D	B				Grease	Oil	
782/772	104.775	180.975	47.625	3.6	259 200	394 200	2 100	2 800	4.830
786/772	104.775	180.975	47.625	6.4	259 200	394 200	2 100	2 800	4.800
795/792	120.650	206.375	47.625	3.2	293 400	493 200	1 700	2 300	8.870
799/792	128.588	206.375	47.625	3.2	293 400	493 200	1 700	2 300	5.840
850/832	88.900	168.275	53.975	3.6	309 600	420 300	2 300	3 100	5.100
898/892	139.700	228.600	57.150	3.6	395 100	657 000	1 600	2 100	8.700
90334/90744	85.001	188.913	53.297	3.6	237 600	302 400	1 700	2 400	6.500
9285/9220	76.200	161.925	49.213	3.6	221 400	257 400	2 100	2 900	4.360
938/932	114.300	212.725	66.675	7.1	405 000	606 600	1 800	2 400	9.900
9385/9321	84.138	171.450	49.213	3.6	225 000	269 100	1 900	2 700	4.690
95475/95925	120.650	234.950	63.500	6.4	470 700	743 400	1 600	2 100	12.340
98394X/98788	100.000	200.000	52.761	3.6	312 300	423 900	1 400	1 900	6.930
99550/99100	139.700	254.000	66.675	7.1	494 100	821 700	1 400	1 900	14.070
H 414245/H 414210	68.263	136.525	41.275	3.6	216 900	277 200	2 900	3 800	2.750
H 414249/H 414210	71.438	136.525	41.275	3.6	216 900	277 200	2 900	3 800	2.700
H 715332/H 715311	60.325	136.525	46.038	3.6	207 900	332 100	2 800	3 700	3.510
H 715341/H 715311	66.675	136.525	46.038	3.6	207 900	332 100	2 800	3 700	3.240
H 715345/H 715311	71.438	136.525	46.038	3.6	207 900	332 100	2 800	3 700	3.120
H 913849/H 913810	69.850	146.050	41.275	3.6	181 800	213 300	2 300	3 300	2.850
HH 221431/HH 221410	79.375	190.500	57.150	3.6	396 000	541 800	2 000	2 700	8.370
HH 221449/HH 221410	101.600	190.500	57.150	7.9	396 000	541 800	2 000	2 700	6.920
HH 224335/HH 224310	101.600	212.725	66.675	7.1	461 700	629 100	1 800	2 400	10.790
HH 224346/HH 224310	114.300	212.725	66.675	7.1	461 700	629 100	1 800	2 400	10.440
HH 224349/HH 224310	114.975	212.725	66.675	7.1	461 700	629 100	1 800	2 400	9.610
HH 228349/HH 228310	127.000	254.000	77.788	9.5	645 300	945 000	1 500	2 000	17.800
HM 212047/HM 212011	63.500	122.238	38.100	7.1	171 900	224 100	3 200	4 300	1.904
HM 212049/HM 212010	66.675	122.238	38.100	3.6	171 900	224 100	3 200	4 300	1.870
HM 212049/HM 212011	66.675	122.238	38.100	3.6	171 900	224 100	3 200	4 300	1.852
HM 218248/HM 218210	89.974	146.975	40.000	7.1	185 400	279 000	2 500	3 300	2.560
HM 220149/HM 220110	99.975	156.975	42.000	7.9	220 500	356 400	2 300	3 100	3.012
HM 231132/HM 231110	139.700	236.538	57.150	3.6	449 100	748 800	1 500	2 000	10.050
HM 231140/HM 231110	146.050	236.536	57.150	3.6	449 100	748 800	1 500	2 000	9.450
HM 231148/HM 231110	149.225	236.538	57.150	6.4	449 100	748 800	1 500	2 000	9.150



Bearing No.	Boundary dimensions(mm)			r(mm)	Cr(N)	Cor(N)	Limiting Speed (min-1)		Mass (Kg)
	d	D	B				Grease	Oil	
HM 516449/HM 516410	82.550	133.350	39.688	3.6	159 300	275 400	2 800	3 700	2.110
HM 518445/HM 518410	88.900	152.400	39.688	6.4	223 200	323 100	2 400	3 200	2.810
HM 617049/HM 617010	85.725	142.138	42.863	4.8	197 100	315 900	2 600	3 500	2.620
HM 803145/HM 803110	41.275	88.900	30.163	0.8	89 640	112 500	4 600	6 100	0.895
HM 803146/HM 803110	41.275	88.900	30.163	3.6	89 640	112 500	4 600	6 100	0.890
HM 803149/HM 803110	44.450	88.900	30.163	3.6	89 640	112 500	4 600	6 100	0.840
HM 803149/HM 803112	44.450	92.075	30.163	3.6	89 640	112 500	4 600	6 100	0.898
HM 804843/HM 804810	44.450	95.250	30.163	3.6	93 600	126 000	3 300	4 400	1.020
HM 804846/HM 804810	47.625	95.250	30.163	3.6	93 600	126 000	3 300	4 400	0.968
HM 804848/HM 804810	48.412	95.250	30.163	2.4	93 600	126 000	3 300	4 400	0.960
HM 807040/HM 807010	44.450	104.775	36.513	3.6	126 900	175 500	3 800	5 100	1.584
HM 807044/HM 807010	49.213	104.775	36.513	3.6	126 900	175 500	3 800	5 100	1.520
HM 807046/HM 807010	50.800	104.775	36.513	3.6	126 900	175 500	3 800	5 100	1.510
HM 88649/HM 88610	34.925	72.233	25.400	2.4	60 000	78 700	5 700	7 600	0.500
HM 903249/HM 903210	44.450	95.250	30.958	3.6	89 800	108 000	3 700	5 100	1.017
HM 911244/HM 911216	59.987	134.983	33.449	3.6	137 700	162 900	2 600	3 700	2.170
HM 926740/HM 926710	114.300	228.600	53.975	3.6	387 000	585 900	1 300	1 900	9.860
HM 926745/HM 926710	125.298	228.600	53.975	3.6	387 000	585 900	1 300	1 900	9.180
HM 926747/HM 926710	127.000	228.600	53.975	3.6	387 000	585 900	1 300	1 900	8.740
JH 211749/JH 211710	65	120	39	3	170 100	229 500	3 200	4 300	1.860
JH 307749/JH 307710	55	110	39	3	158 400	201 600	3 600	4 900	1.710
JH 415647/JH 415610	75	145	51	3	261 000	370 800	2 700	3 600	3.810
JHM 318448/JHM 318410	90	155	44	3	261 000	366 300	2 400	3 200	3.370
JHM 516849/JHM 516810	85	140	39	3	182 700	277 200	2 700	3 500	2.270
JHM 522649/JHM 522610	110	180	47	3	275 400	438 300	2 000	2 700	4.540
JHM 534149/JHM 534110	170	230	39	3	261 900	502 200	1 400	1 900	4.320
JHM 720249/JHM 720210	100	160	41	3	213 300	340 200	2 300	3 000	3.000
JHM 807045/JHM 807012	50	105	37	3	134 100	184 500	3 800	5 100	1.540
JL 69349/JL 69310	38	63	17	3	39 200	52 400	6 000	8 000	0.200
JLM 104948/JLM 104910	50	82	21.5	3	64 500	88 100	4 500	6 000	0.435
JLM 506849/JLM 506810	55	90	23	1.6	73 300	103 500	4 200	5 500	0.551
JLM 704649/JLM 704610	50	84	22	3.5	63 200	86 600	4 500	6 000	0.485
JLM 710949/JLM 710910	65	105	24	3	85 700	116 000	3 500	4 700	0.736

## Tapered Roller Bearings

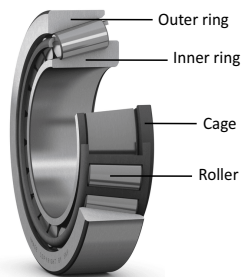
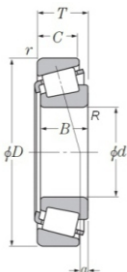

Bearing No.	Boundary dimensions(mm)			r(mm)	Cr(N)	Cor(N)	Limiting Speed (min-1)		Mass (Kg)
	d	D	B				Grease	Oil	
JLM 714149/JLM 714110	75	115	25	3	91 000	136 000	3 100	4 200	0.880
JLM 813049/JLM 813010	70	110	26	1	92 700	142 000	3 300	4 400	0.890
JM 205149/JM 205110	50	90	28	3	94 500	124 200	4 300	5 800	0.738
JM 207049/JM 207010	55	95	29	1.5	99 000	135 000	4 000	5 300	0.840
JM 207049A/JM 207010	55	95	29	6	99 000	135 000	4 000	5 300	0.814
JM 511946/JM 511910	65	110	28	3	122 400	171 900	3 400	4 600	1.050
JM 515649/JM 515610	80	130	35	3	151 200	230 400	2 800	3 800	1.820
JM 612949/JM 612910	70	115	29	3	110 700	155 700	3 200	4 300	1.030
JM 714249/JM 714210	75	120	31	3	130 500	194 400	3 100	4 100	1.300
JM 716648/JM 716610	85	130	30	6	127 800	205 200	2 800	3 700	1.350
JM 716649/JM 716610	85	130	30	3	127 800	205 200	2 800	3 700	1.350
JM 718149A/JM 718110	90	145	35	6	174 600	261 900	2 500	3 400	2.190
JM 718149/JM 718110	90	145	35	3	174 600	261 900	2 500	3 400	2.190
JM 719149/JM 719113	95	150	35	3	168 300	264 600	2 400	3 300	2.170
JM 720249/JM 720210	100	155	36	3	183 600	295 200	2 300	3 100	2.370
JM 734449/JM 734410	170	240	46	3	317 700	599 400	1 400	1 800	6.480
JM 736149/JM 736110	180	250	47	3	328 500	634 500	1 300	1 700	6.570
JM 738249/JM 738210	190	260	46	3	332 100	650 700	1 200	1 700	6.780
JM 822049/JM 822010	110	165	35	3	175 500	292 500	2 200	2 900	2.430
L 44643/L 44610	25.400	50.292	14.224	1.2	28 000	33 300	7 800	10 000	0.130
L 44649/L 44610	26.988	50.292	14.224	3.6	28 000	33 300	7 800	10 000	0.120
L 45449/L 45410	29.000	50.292	14.224	3.6	26 000	33 500	7 600	10 000	0.113
L 540049/L 540010	196.850	254.000	28.575	1.6	169 200	348 300	1 200	1 600	3.360
L 68149/L 68110	34.987	59.131	15.875	1.2	32 200	43 700	6 400	8 500	0.179
L 68149/L 68111	34.987	59.975	15.875	1.2	32 200	43 700	6 400	8 500	0.179
LM 102949/LM 102910	45.242	73.431	19.558	3.6	50 000	70 300	5 100	6 700	0.315
LM 104949/LM 104911	50.800	82.550	21.590	3.6	55 000	75 800	4 500	6 000	0.410
LM 104949/LM 104912	50.800	82.931	21.590	3.6	55 000	75 800	4 500	6 000	0.421
LM 11749/LM 11710	17.463	39.878	13.843	1.2	22 900	23 400	11 000	14 000	0.084
LM 11949/LM 11910	19.050	45.237	15.494	1.2	26 500	27 000	9 400	13 000	0.122
LM 12749/LM 12710	21.987	45.237	15.494	1.27	27 000	31 200	8 900	12 000	0.123
LM 12749/LM 12711	21.987	45.975	15.494	1.27	27 000	31 200	8 900	12 000	0.123
LM 29748/LM 29710	38.100	65.088	18.034	SP	38 600	50 800	5 800	7 800	0.220



Bearing No.	Boundary dimensions(mm)			r(mm)	Cr(N)	Cor(N)	Limiting Speed (min-1)		Mass (Kg)
	d	D	B				Grease	Oil	
LM 29749/LM 29710	38.100	65.088	18.034	2,36	38 600	50 800	5 800	7 800	0.236
LM 29749/LM 29711	38.100	65.088	19.812	2,36	38 600	50 800	5 800	7 800	0.251
LM 300849/LM 300811	40.987	67.975	17.500	3,6	39 600	53 500	5 500	7 400	0.240
LM 48548/LM 48510	34.925	65.088	18.034	3,6	43 200	52 700	6 000	8 000	0.259
LM 48548/LM 48511A	34.925	65.088	21.082	3,6	43 200	52 700	6 000	8 000	0.277
LM 48548A/LM 48510	34.925	65.088	18.034	0,8	43 200	52 700	6 000	8 000	0.255
LM 48548A/LM 48511A	34.925	65.088	21.082	0,8	43 200	52 700	6 000	8 000	0.282
LM 501349/LM 501310	41.275	73.431	19.558	3,6	52 000	65 700	5 200	7 000	0.342
LM 501349/LM 501314	41.275	73.431	21.430	3,6	52 000	65 700	5 200	7 000	0.360
LM 603049/LM 603011	45.242	77.788	19.842	3,6	51 400	66 200	4 900	6 500	0.368
LM 603049/LM 603012	45.242	77.788	21.430	3,6	51 400	66 200	4 900	6 500	0.390
LM 603049/LM 603014	45.242	79.974	19.842	3,6	51 400	66 200	4 900	6 500	0.395
LM 67048/LM 67010	31.750	59.131	15.875	3,6	32 300	38 800	6 600	8 800	0.180
LM 814849/LM 814810	77.788	117.475	25.400	3,6	90 900	149 500	3 100	4 100	0.900
M 12649/M 12610	21.430	50.005	17.526	1,17	35 200	36 700	8 500	11 000	0.170
M 201047/M 201011	39.688	73.025	25.654	0,8	61 500	82 000	5 300	7 100	0.445
M 802048/M 802011	41.275	82.550	26.543	3,6	75 400	94 500	4 900	6 500	0.626
M 804049/M 804010	47.625	88.900	25.400	3,6	78 400	100 000	4 400	5 900	0.660
M 84548/M 84510	25.400	57.150	19.431	1,57	38 000	44 300	7 300	9 700	0.245
M 86643/M 86610	25.400	64.292	21.433	1,57	49 700	63 700	6 400	8 500	0.370
M 86647/M 86610	28.575	64.292	21.433	1,6	49 700	63 700	6 400	8 500	0.350
M 86649/M 86610	30.163	64.292	21.433	1,57	49 700	63 700	6 400	8 500	0.330
M 88043/M 88010	30.163	68.263	22.225	2,4	50 500	64 000	6 000	7 900	0.400
M 88046/M 88010	31.750	68.263	22.225	1,6	50 500	64 000	6 000	7 900	0.390
M 88048/M 88010	33.338	68.263	22.225	0,8	50 500	64 000	6 000	7 900	0.380



**ASB<sup>®</sup>** | 



**Spherical  
Roller  
Bearings** | 

## Spherical Roller Bearings

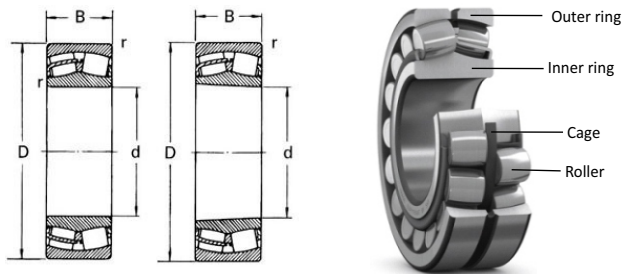

Bearing No.	Boundary dimensions(mm)			r(mm)	Cr(N)	Cor(N)	Limiting Speed (min-1)		Mass (Kg)
	d	D	B				Grease	Oil	
21304	20	52	15	1.1	47 000	33 500	11 000	14 000	0.160
21305	25	62	17	1.1	64 000	47 500	9 000	11 500	0.280
21306	30	72	19	1.1	83 000	62 500	8 000	9 500	0.402
21307	35	80	21	1.5	96 000	76 000	7 000	8 500	0.536
21308	40	90	23	1.5	119 000	95 500	6 000	7 500	0.750
21309	45	100	25	1.5	150 000	124 000	5 000	6 300	1.002
21310	50	110	27	2	178 000	151 000	4 500	5 600	1.350
21311	55	120	29	2	200 000	165 000	4 500	5 600	1.700
21312	60	130	31	2.1	238 000	193 000	3 800	4 800	2.100
21313	65	140	33	2.1	270 000	232 000	3 600	4 500	2.576
21314	70	150	35	2.1	310 000	260 000	3 200	4 000	3.100
21315	75	160	37	2.1	340 000	298 000	3 200	4 000	3.750
21316	80	170	39	2.1	380 000	339 000	3 000	3 800	4.450
21317	85	180	41	3	415 000	372 000	3 000	4 000	5.268
21318	90	190	43	3	460 000	410 000	2 800	3 600	6.100
21319	95	200	45	3	500 000	461 000	2 700	3 400	6.960
21320	100	215	47	3	580 000	524 000	2 400	3 300	8.680
21322	110	240	50	3	675 000	635 000	2 100	2 850	11.740
21324	120	260	55	3	790 000	765 000	1 950	2 400	15.300





Steel Cage



Brass Cage

Bearing No.	Boundary dimensions(mm)			r(mm)	Cr(N)	Cor(N)	Limiting Speed (min-1)		Mass (Kg)
	d	D	B				Grease	Oil	
22205	25	52	18	1	63 000	48 000	10 500	13 000	0.176
22206	30	62	20	1	84 500	65 000	8 500	11 000	0.272
22207	35	72	23	1.1	112 000	88 500	7 500	9 500	0.438
22208	40	80	23	1.1	126 000	102 000	6 700	8 500	0.530
22209	45	85	23	1.1	133 000	110 000	6 000	7 500	0.570
22210	50	90	23	1.1	142 000	122 000	5 600	7 100	0.612
22211	55	100	25	1.5	171 000	144 000	5 300	6 700	0.822
22212	60	110	28	1.5	210 000	179 000	4 800	6 000	1.150
22213	65	120	31	1.5	246 000	209 000	4 300	5 300	1.518
22214	70	125	31	1.5	257 000	220 000	4 000	5 300	1.550
22215	75	130	31	1.5	265 000	234 000	4 000	5 000	1.668
22216	80	140	33	2	299 000	269 000	3 600	4 500	2.082
22217	85	150	36	2	355 000	320 000	3 400	4 300	2.650
22218	90	160	40	2	410 000	375 000	3 200	4 000	3.322
22219	95	170	43	2.1	465 000	420 000	3 000	3 800	4.068
22220	100	180	46	2.1	520 000	480 000	2 800	3 600	4.900
22222	110	200	53	2.1	680 000	640 000	2 600	3 200	7.040
22224	120	215	58	2.1	785 000	765 000	2 400	3 000	8.800
22226	130	230	64	3	910 000	915 000	2 200	2 600	11.000
22228	140	250	68	3	1 050 000	1 030 000	1 900	2 500	13.760
22230	150	270	73	3	1 200 000	1 200 000	1 800	2 400	18.000
22232	160	290	80	3	1 230 000	1 330 000	1 500	2 100	22.500
22234	170	310	86	4	1 390 000	1 510 000	1 400	1 900	28.040
22236	180	320	86	4	1 460 000	1 610 000	1 400	1 900	28.720
22238	190	340	92	4	1 590 000	1 740 000	1 300	1 800	35.080
22240	200	360	98	4	1 810 000	1 990 000	1 200	1 600	46.740
22244	220	400	108	4	2 140 000	2 380 000	1 200	1 500	60.500
22248	240	440	120	4	2 630 000	2 930 000	1 000	1 300	83.000
22252	260	480	130	5	3 100 000	3 500 000	1 000	1 200	110.000
22256	280	500	130	5	3 200 000	3 700 000	940	1 200	116.000
22260	300	540	140	5	3 700 000	4 300 000	900	1 100	140.000
22264	320	580	150	5	4 250 000	4 900 000	820	1 000	175.000
22268	340	620	165	6	5 600 000	6 850 000	750	930	223.000

# Spherical Roller Bearings

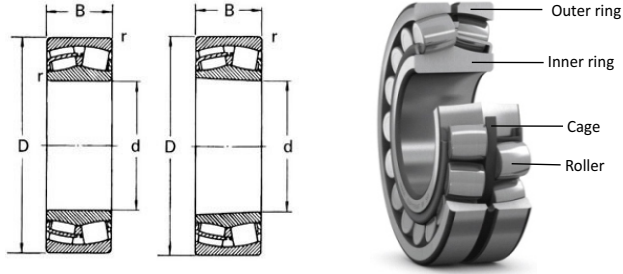

Bearing No.	Boundary dimensions(mm)			r(mm)	Cr(N)	Cor(N)	Limiting Speed (min-1)		Mass (Kg)
	d	D	B				Grease	Oil	
22308	40	90	33	1.5	185 000	151 000	5 300	6 700	1.030
22309	45	100	36	1.5	230 000	182 000	4 500	5 600	1.344
22310	50	110	40	2	280 000	235 000	4 300	5 300	1.816
22311	55	120	43	2	325 000	263 000	3 800	4 800	2.280
22312	60	130	46	2.1	390 000	330 000	3 600	4 500	2.974
22313	65	140	48	2.1	415 000	355 000	3 200	4 000	3.370
22314	70	150	51	2.1	480 000	415 000	3 000	3 800	4.200
22315	75	160	55	2.1	550 000	475 000	2 800	3 600	5.160
22316	80	170	58	2.1	595 000	520 000	2 600	3 400	5.950
22317	85	180	60	3	665 000	585 000	2 400	3 200	7.120
22318	90	190	64	3	745 000	660 000	2 400	3 000	8.460
22319	95	200	67	3	815 000	725 000	2 200	2 900	9.820
22320	100	215	73	3	975 000	875 000	2 000	2 800	12.460
22322	110	240	80	3	1 150 000	1 040 000	1 950	2 700	17.520
22324	120	260	86	3	1 250 000	1 130 000	1 800	2 600	21.440
22326	130	280	93	4	1 450 000	1 340 000	1 700	2 500	27.140
22328	140	300	102	4	1 540 000	1 520 000	1 600	2 200	33.380
22330	150	320	108	4	1 770 000	1 740 000	1 500	2 100	43.500
22332	160	340	114	4	1 950 000	1 950 000	1 400	1 900	52.000
22334	170	360	120	4	2 150 000	2 200 000	1 300	1 800	61.000
22336	180	380	126	4	2 380 000	2 400 000	1 200	1 600	71.000
22338	190	400	132	5	2 600 000	2 670 000	1 200	1 600	88.500
22340	200	420	138	5	2 890 000	3 000 000	1 200	1 500	95.000
22344	220	460	145	5	3 350 000	3 600 000	1 000	1 300	120.000
22348	240	500	155	5	3 850 000	4 100 000	1 000	1 200	148.000
22352	260	540	165	6	4 350 000	4 750 000	900	1 100	183.000
22356	280	580	175	6	4 950 000	5 450 000	840	1 000	235.000
22360	300	620	185	7.5	5 500 000	6 050 000	780	970	274.000



Steel Cage



Brass Cage

Bearing No.	Boundary dimensions(mm)			r(mm)	Cr(N)	Cor(N)	Limiting Speed (min-1)		Mass (Kg)
	d	D	B				Grease	Oil	
23020	100	150	37	1.5	286 000	325 000	2 700	3 700	2.300
23022	110	170	45	2	415 000	475 000	2 700	3 600	3.800
23024	120	180	46	2	430 000	515 000	2 550	3 300	4.200
23026	130	200	52	2	555 000	660 000	2 400	3 000	6.100
23028	140	210	53	2	585 000	710 000	2 400	2 800	6.550
23030	150	225	56	2.1	640 000	790 000	1 900	2 500	7.950
23032	160	240	60	2.1	735 000	915 000	1 800	2 400	9.700
23034	170	260	67	2.1	880 000	1 080 000	1 600	2 200	13.000
23036	180	280	74	2.1	1 070 000	1 330 000	1 500	2 200	17.000
23038	190	290	75	2.1	1 080 000	1 330 000	1 400	1 900	18.000
23040	200	310	82	2.1	1 270 000	1 560 000	1 400	1 900	23.000
23044	220	340	90	3	1 470 000	1 880 000	1 200	1 600	30.500
23048	240	360	92	3	1 530 000	2 000 000	1 200	1 500	33.500
23052	260	400	104	4	1 950 000	2 530 000	1 100	1 400	48.500
23056	280	420	106	4	2 030 000	2 720 000	1 000	1 300	52.500
23060	300	460	118	4	2 500 000	3 300 000	940	1 200	71.000
23064	320	480	121	4	2 590 000	3 500 000	900	1 100	78.000
23068	340	520	133	5	3 150 000	4 300 000	840	1 000	105.000
23072	360	540	134	5	3 200 000	4 500 000	790	1 000	111.000
23076	380	560	135	5	3 300 000	4 700 000	750	940	120.000
23080	400	600	148	5	3 900 000	5 500 000	720	900	150.000
23084	420	620	150	5	4 050 000	5 850 000	670	840	155.000
23088	440	650	157	6	4 300 000	6 250 000	640	790	182.000
23092	460	680	163	6	4 700 000	6 850 000	600	750	205.000
23096	480	700	165	6	4 850 000	7 250 000	570	720	215.000

# Spherical Roller Bearings

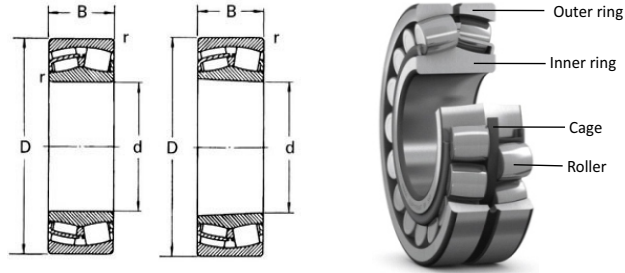

Bearing No.	Boundary dimensions(mm)			r(mm)	Cr(N)	Cor(N)	Limiting Speed (min-1)		Mass (Kg)
	d	D	B				Grease	Oil	
23120	100	165	52	2	450 000	500 000	2 500	3 300	4.550
23122	110	180	56	2	540 000	610 000	2 700	3 600	5.550
23124	120	200	62	2	675 000	720 000	2 400	3 300	7.800
23126	130	210	64	2	690 000	799 000	2 200	3 000	8.550
23128	140	225	68	2.1	790 000	940 000	2 100	2 850	10.500
23130	150	250	80	2.1	1 000 000	1 230 000	1 900	2 500	16.000
23132	160	270	86	2.1	1 180 000	1 430 000	1 800	2 400	20.500
23134	170	280	88	2.1	1 260 000	1 530 000	1 600	2 200	21.500
23136	180	300	96	3	1 490 000	1 810 000	1 300	1 800	26.860
23138	190	320	104	3	1 720 000	2 120 000	1 200	1 600	34.500
23140	200	340	112	3	1 950 000	2 390 000	1 200	1 500	41.300
23144	220	370	120	4	2 250 000	2 870 000	1 000	1 300	53.000
23148	240	400	128	4	2 610 000	3 350 000	1 000	1 200	65.500
23152	260	440	144	4	3 100 000	4 000 000	900	1 100	90.500
23156	280	460	146	5	3 200 000	4 200 000	840	1 000	97.000
23160	300	500	160	5	3 650 000	4 750 000	790	1 000	125.000
23164	320	540	176	5	4 350 000	5 700 000	720	900	166.000
23168	340	580	190	5	5 150 000	6 750 000	670	840	210.000
23172	360	600	192	5	5 350 000	7 250 000	640	790	221.000
23176	380	620	194	5	5 400 000	7 400 000	600	750	230.000
23180	400	650	200	6	5 750 000	7 900 000	570	720	265.000
23184	420	700	224	6	6 800 000	9 250 000	540	670	350.000
23188	440	720	226	6	7 150 000	10 000 000	510	640	360.000
23192	460	760	240	7.5	8 000 000	11 200 000	480	600	446.000
23196	480	790	248	7.5	8 500 000	12 000 000	450	570	495.000



Steel Cage



Brass Cage

Bearing No.	Boundary dimensions(mm)			r(mm)	Cr(N)	Cor(N)	Limiting Speed (min-1)		Mass (Kg)
	d	D	B				Grease	Oil	
23218	90	160	52.4	2	470 000	482 000	3 100	4 200	4.600
23219	95	170	55.6	2.1	500 000	510 000	2 800	3 600	5.460
23220	100	180	60.3	2.1	595 000	629 000	2 800	3 750	6.850
23222	110	200	69.8	2.1	750 000	793 000	2 550	3 300	9.850
23224	120	215	76	2.1	860 000	956 000	2 250	3 150	12.000
23226	130	230	80	3	980 000	1 090 000	2 100	2 800	13.820
23228	140	250	88	3	1 130 000	1 290 000	1 900	2 500	18.500
23230	150	270	96	3	1 340 000	1 540 000	1 800	2 400	23.560
23232	160	290	104	3	1 500 000	1 710 000	1 300	1 800	30.000
23234	170	310	110	4	1 720 000	1 970 000	1 300	1 800	36.500
23236	180	320	112	4	1 790 000	2 100 000	1 200	1 600	39.500
23238	190	340	120	4	2 070 000	2 450 000	1 200	1 500	48.000
23240	200	360	128	4	2 290 000	2 750 000	1 200	1 500	58.000
23244	220	400	144	4	2 920 000	3 500 000	1 000	1 200	81.500
23248	240	440	160	4	3 400 000	4 100 000	945	1 200	107.000
23252	260	480	174	5	3 950 000	4 800 000	840	1 000	140.000
23256	280	500	176	5	4 150 000	5 200 000	790	1 000	150.000
23260	300	540	192	5	4 950 000	6 250 000	720	900	190.000
23264	320	580	208	5	5 600 000	7 200 000	670	840	240.000
23268	340	620	224	6	6 300 000	8 000 000	600	790	301.000
23272	360	650	232	6	6 950 000	9 000 000	570	750	335.000
23276	380	680	240	6	7 500 000	9 800 000	540	720	402.000
23280	400	720	256	6	8 500 000	11 100 000	510	670	442.000
23284	420	760	272	7.5	9 400 000	12 500 000	490	640	539.000
23288	440	790	280	7.5	10 000 000	13 300 000	480	600	605.000
23292	460	830	296	7.5	10 600 000	14 500 000	450	570	709.000
23296	480	870	310	7.5	11 300 000	15 400 000	420	540	820.000

## Spherical Roller Bearings

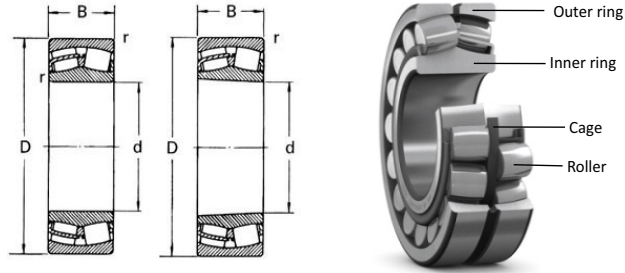

Bearing No.	Boundary dimensions(mm)			r(mm)	Cr(N)	Cor(N)	Limiting Speed (min-1)		Mass (Kg)
	d	D	B				Grease	Oil	
23926	130	180	37	1.5	284 000	355 000	2 700	3 450	2.870
23928	140	190	37	1.5	345 000	466 000	2 550	3 300	2.900
23930	150	210	45	2	465 000	622 000	2 400	3 000	5.010
23932	160	220	45	2	475 000	649 000	2 250	2 800	5.290
23934	170	230	45	2	490 000	691 000	2 100	2 700	5.580
23936	180	250	52	2	665 000	939 000	1 900	2 500	8.100
23938	190	260	52	2	675 000	969 000	1 800	2 400	8.450
23940	200	280	60	2.1	840 000	1 190 000	1 800	2 200	11.900
23944	220	300	60	2.1	840 000	1 190 000	1 300	1 800	12.600
23948	240	320	60	2.1	870 000	1 260 000	1 200	1 600	13.700
23952	260	360	75	2.1	1 240 000	1 780 000	1 200	1 500	23.700
23956	280	380	75	2.1	1 260 000	1 840 000	1 100	1 400	24.900
23960	300	420	90	3	1 740 000	2 520 000	1 000	1 200	39.700
23964	320	440	90	3	1 770 000	2 610 000	940	1 200	41.800
23968	340	460	90	3	1 830 000	2 790 000	900	1 100	44.000
23972	360	480	90	3	1 890 000	2 960 000	900	1 100	46.200
23976	380	520	106	4	2 390 000	3 650 000	790	1 000	68.200
23980	400	540	106	4	2 470 000	3 900 000	750	940	71.400
23984	420	560	106	4	2 520 000	4 000 000	720	900	74.500
23988	440	600	118	4	3 100 000	4 900 000	670	840	100.000
23992	460	620	118	4	3 050 000	4 900 000	640	790	105.000
23996	480	650	128	5	3 300 000	5 450 000	645	790	126.000



Steel Cage



Brass Cage

Bearing No.	Boundary dimensions(mm)			r(mm)	Cr(N)	Cor(N)	Limiting Speed (min-1)		Mass (Kg)
	d	D	B				Grease	Oil	
24024	120	180	60	2	540 000	683 000	2 550	3 450	5.450
24026	130	200	69	2	710 000	900 000	2 400	3 150	7.840
24028	140	210	69	2	720 000	920 000	2 200	3 000	8.550
24030	150	225	75	2.1	815 000	1 060 000	2 100	2 700	10.500
24032	160	240	80	2.1	950 000	1 280 000	1 900	2 500	13.000
24034	170	260	90	2.1	1 120 000	1 480 000	1 800	2 400	17.500
24036	180	280	100	2.1	1 330 000	1 760 000	1 600	2 100	22.540
24038	190	290	100	2.1	1 420 000	1 920 000	1 300	1 800	22.450
24040	200	310	109	2.1	1 640 000	2 230 000	1 200	1 600	31.000
24044	220	340	118	3	1 950 000	2 670 000	1 200	1 500	40.000
24048	240	360	118	3	1 990 000	2 800 000	1 000	1 300	41.800
24052	260	400	140	4	2 630 000	3 700 000	940	1 200	65.600
24056	280	420	140	4	2 680 000	3 900 000	900	1 100	67.400
24060	300	460	160	4	3 350 000	4 850 000	840	1 000	95.500
24064	320	480	160	4	3 400 000	5 100 000	790	1 000	100.000
24068	340	520	180	5	4 100 000	6 050 000	720	900	140.000
24072	360	540	180	5	4 250 000	6 350 000	670	840	145.000
24076	380	560	180	5	4 300 000	6 650 000	670	840	150.000
24080	400	600	200	5	5 000 000	7 650 000	600	750	203.000
24084	420	620	200	5	5 150 000	8 000 000	570	720	222.000
24088	440	650	212	6	5 750 000	9 000 000	540	670	245.000
24092	460	680	218	6	6 100 000	9 650 000	510	640	279.000
24096	480	700	218	6	6 300 000	10 100 000	510	640	290.000

# Spherical Roller Bearings

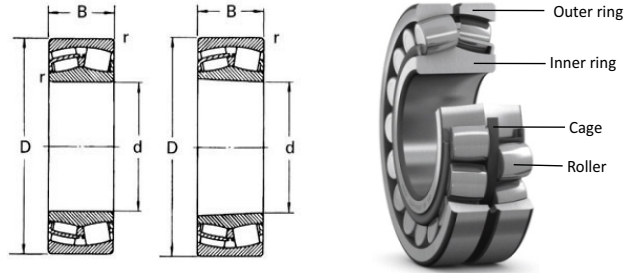

Bearing No.	Boundary dimensions(mm)			r(mm)	Cr(N)	Cor(N)	Limiting Speed (min-1)		Mass (Kg)
	d	D	B				Grease	Oil	
24122	110	180	69	2	633 000	743 000	2700	3600	7.100
24124	120	200	80	2	815 000	970 000	2400	3300	10.300
24126	130	210	80	2	840 000	1 030 000	2200	3000	11.000
24128	140	225	85	2.1	950 000	1 180 000	2100	2800	13.500
24130	150	250	100	2.1	1 230 000	1 520 000	1900	2500	20.000
24132	160	270	109	2.1	1 450 000	1 810 000	1800	2400	25.000
24134	170	280	109	2.1	1 360 000	1 650 000	1600	2200	27.500
24136	180	300	118	3	1 640 000	2 040 000	1350	1800	31.800
24138	190	320	128	3	1 900 000	2 380 000	1200	1600	40.000
24140	200	340	140	3	2 220 000	2 820 000	1200	1500	49.500
24144	220	370	150	4	2 530 000	3 250 000	1100	1400	64.700
24148	240	400	160	4	2 850 000	3 700 000	1000	1200	79.000
24152	260	440	180	4	3 550 000	4 650 000	900	1100	111.500
24156	280	460	180	5	3 550 000	4 800 000	840	1000	120.000
24160	300	500	200	5	4 450 000	6 100 000	790	1000	160.000
24164	320	540	218	5	5 050 000	6 900 000	720	900	205.000
24168	340	580	243	5	6 050 000	8 300 000	670	840	267.000
24172	360	600	243	5	6 250 000	8 750 000	640	790	270.000
24176	380	620	243	5	6 450 000	9 300 000	600	750	290.000
24180	400	650	250	6	6 900 000	9 850 000	570	720	330.000
24184	420	700	280	6	8 350 000	12 000 000	540	670	445.000
24188	440	720	280	6	8 550 000	12 700 000	510	640	460.000
24192	460	760	300	7.5	9 450 000	13 900 000	480	600	550.000
24196	480	790	308	7.5	9 950 000	14 800 000	450	570	625.000





Steel Cage



Brass Cage



**ASB<sup>®</sup>**

**Spherical  
Roller  
Thrust  
Bearings**

## Spherical Roller Thrust Bearings

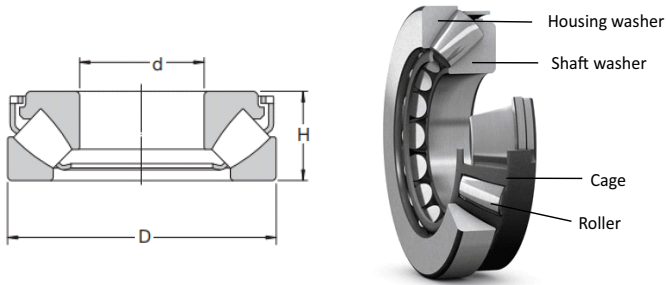

Bearing No.	Boundary dimensions(mm)			r(mm)	Cr(N)	Cor(N)	Limiting Speed (min-1)		Mass (Kg)
	d	D	H				Grease	Oil	
29234	170	240	42	1.5	351 000	1 530 000	-	1 900	5.950
29236	180	250	42	1.5	378 000	1 710 000	-	1 900	5.800
29238	190	270	48	2	486 000	2 070 000	-	1 800	7.800
29240	200	280	48	2	495 000	2 170 000	-	1 800	8.840
29244	220	300	48	2	535 000	2 475 000	-	1 600	9.730
29248	240	340	60	2.1	800 000	3 600 000	-	1 300	16.500
29252	260	360	60	2.1	823 000	3 825 000	-	1 300	16.720
29256	280	380	60	2.1	842 000	4 050 000	-	1 200	19.600
29260	300	420	73	3	1 100 000	5 265 000	-	1 000	30.700
29264	320	440	73	3	1 143 000	5 535 000	-	980	32.500
29268	340	460	73	3	1 160 000	5 715 000	-	950	34.300
29272	360	500	85	4	1 485 000	7 245 000	-	830	49.120
29276	380	520	85	4	1 600 000	7 920 000	-	800	51.600
29280	400	540	85	4	1 656 000	8 325 000	-	800	54.170
29284	420	580	95	5	2 034 000	10 170 000	-	700	73.630
29288	440	600	95	5	2 060 000	10 620 000	-	660	78.140
29292	460	620	95	5	2 060 000	10 700 000	-	660	80.320
29296	480	650	103	5	2 277 000	11 800 000	-	600	96.760



Steel Cage



Brass Cage

Bearing No.	Boundary dimensions(mm)			r(mm)	Cr(N)	Cor(N)	Limiting Speed (min-1)		Mass (Kg)
	d	D	H				Grease	Oil	
29317	85	150	39	1.5	264 000	890 000	-	2 700	2.750
29318	90	155	39	1.5	270 000	936 000	-	2 700	2.850
29320	100	170	42	1.5	320 000	1 134 000	-	2 500	3.650
29322	110	190	48	2	423 000	1 512 000	-	2 100	5.300
29324	120	210	54	2.1	508 000	1 827 000	-	1 900	7.350
29326	130	225	58	2.1	598 000	2 178 000	-	1 800	9.000
29328	140	240	60	2.1	630 000	2 300 000	-	1 600	10.500
29230	150	215	39	1.5	300 000	1 250 000	-	2 100	4.300
29330	150	250	60	2.1	660 000	2 550 000	-	1 600	11.000
29232	160	225	39	1.5	310 000	1 323 000	-	2 100	4.750
29332	160	270	67	3	792 000	3 060 000	-	1 400	14.500
29334	170	280	67	3	810 000	3 200 000	-	1 400	15.000
29336	180	300	73	3	918 000	3 555 000	-	1 300	19.500
29338	190	320	78	4	1 053 000	4 100 000	-	1 100	23.500
29340	200	340	85	4	1 215 000	4 725 000	-	1 000	29.500
29344	220	360	85	4	1 269 000	5 175 000	-	1 000	33.500
29348	240	380	85	4	1 269 000	5 265 000	-	980	34.400
29352	260	420	95	5	1 629 000	6 750 000	-	860	49.400
29356	280	440	95	5	1 665 000	7 155 000	-	840	53.000
29360	300	480	109	5	2 080 000	9 000 000	-	720	76.100
29364	320	500	109	5	2 135 000	9 540 000	-	720	78.000
29368	340	540	122	5	2 565 000	11 160 000	-	630	104.360
29372	360	560	122	5	2 600 000	11 600 000	-	600	110.600
29376	380	600	132	6	3 060 000	13 800 000	-	540	138.400
29380	400	620	132	6	3 195 000	14 670 000	-	530	144.350
29384	420	650	140	6	3 510 000	16 100 000	-	480	169.100
29388	440	680	145	6	3 645 000	17 100 000	-	450	190.900
29392	460	710	150	6	4 140 000	19 500 000	-	430	214.500
29396	480	730	150	6	4 167 000	19 700 000	-	410	222.700

## Spherical Roller Thrust Bearings

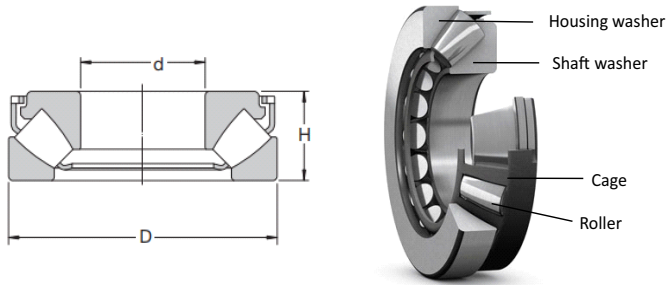

Bearing No.	Boundary dimensions(mm)			r(mm)	Cr(N)	Cor(N)	Limiting Speed (min <sup>-1</sup> )		Mass (Kg)
	d	D	H				Grease	Oil	
29412	60	130	42	1.5	269 000	800 000	-	2 800	2.600
29413	65	140	45	2	310 000	936 000	-	2 700	3.320
29414	70	150	48	2	337 000	1 000 000	-	2 400	3.900
29415	75	160	51	2	400 000	1 242 000	-	2 300	4.700
29416	80	170	54	2.1	432 000	1 341 000	-	2 100	5.600
29417	85	180	58	2.1	486 000	1 548 000	-	2 000	6.750
29418	90	190	60	2.1	558 000	1 818 000	-	1 900	7.750
29420	100	210	67	3	621 000	2 000 000	-	1 700	10.500
29422	110	230	73	3	760 000	2 538 000	-	1 500	13.500
29424	120	250	78	4	927 000	3 100 000	-	1 400	17.500
29426	130	270	85	4	1 025 000	3 465 000	-	1 200	21.000
29428	140	280	85	4	1 080 000	3 645 000	-	1 200	23.000
29430	150	300	90	4	1 197 000	4 140 000	-	1 100	28.000
29432	160	320	95	5	1 360 000	4 800 000	-	1 000	35.950
29434	170	340	103	5	1 500 000	5 300 000	-	950	39.540
29436	180	360	109	5	1 755 000	6 300 000	-	860	52.500
29438	190	380	115	5	1 900 000	6 975 000	-	800	61.300
29440	200	400	122	5	2 115 000	7 600 000	-	740	64.000



Steel Cage



Brass Cage

Bearing No.	Boundary dimensions(mm)			r(mm)	Cr(N)	Cor(N)	Limiting Speed (min-1)		Mass (Kg)
	d	D	H				Grease	Oil	
29444	220	420	122	6	2 169 000	8 055 000	-	720	75.000
29448	240	440	122	6	2 232 000	8 500 000	-	720	78.400
29452	260	480	132	6	2 646 000	10 450 000	-	640	93.000
29456	280	520	145	6	3 100 000	12 150 000	-	580	122.300
29460	300	540	145	6	3 285 000	13 320 000	-	540	129.000
29464	320	580	155	7.5	3 645 000	15 120 000	-	480	177.500
29468	340	620	170	7.5	4 275 000	17 370 000	-	430	220.000
29472	360	640	170	7.5	4 400 000	18 450 000	-	410	233.000
29476	380	670	175	7.5	4 680 000	19 800 000	-	400	261.900
29480	400	710	185	7.5	5 265 000	22 500 000	-	360	313.000
29484	420	730	185	7.5	5 445 000	23 400 000	-	360	322.700
29488	440	780	206	9.5	6 255 000	27 000 000	-	300	400.000
29492	460	800	206	9.5	6 435 000	28 350 000	-	290	432.000
29496	480	850	224	9.5	7 425 000	32 400 000	-	260	525.000





**ASB<sup>®</sup>** | 



**Thrust  
Ball  
Bearings** | 

## Thrust Ball Bearings

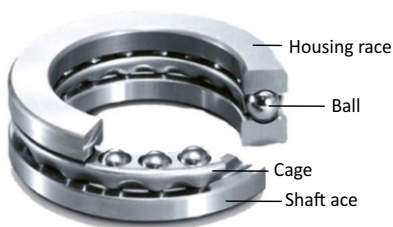
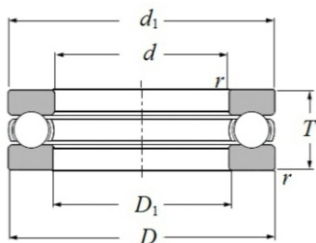

Bearing No.	Boundary dimensions(mm)			r(mm)	Ca(N)	Coa(N)	Limiting Speed (min-1)		Mass (Kg)
	d	D	T				Grease	Oil	
51100	10	24	9	0.3	10 000	14 000	6 800	10 000	0.022
51101	12	26	9	0.3	10 300	15 400	6 500	9 800	0.024
51102	15	28	9	0.3	10 500	16 800	6 200	9 400	0.026
51103	17	30	9	0.3	10 800	18 200	6 000	9 100	0.028
51104	20	35	10	0.3	14 300	24 700	5 200	8 000	0.038
51105	25	42	11	0.6	19 500	37 000	4 600	6 900	0.056
51106	30	47	11	0.6	20 400	42 000	4 300	6 500	0.063
51107	35	52	12	0.6	20 400	44 500	4 000	6 000	0.082
51108	40	60	13	0.6	26 900	63 000	3 500	5 300	0.120
51109	45	65	14	0.6	27 800	69 000	3 300	4 900	0.140
51110	50	70	14	0.6	28 800	75 500	3 100	4 700	0.156
51111	55	78	16	0.6	35 000	93 000	2 800	4 200	0.230
51112	60	85	17	1	41 500	113 000	2 600	3 900	0.288
51113	65	90	18	1	41 500	117 000	2 400	3 700	0.330
51114	70	95	18	1	43 000	127 000	2 400	3 600	0.350
51115	75	100	19	1	44 500	136 000	2 200	3 400	0.393
51116	80	105	19	1	44 500	141 000	2 200	3 300	0.416
51117	85	110	19	1	46 000	150 000	2 100	3 200	0.454
51118	90	120	22	1	59 500	190 000	1 900	2 900	0.670
51120	100	135	25	1	85 000	268 000	1 700	2 500	0.982
51122	110	145	25	1	87 000	288 000	1 600	2 400	1.050
51124	120	155	25	1	89 000	305 000	1 600	2 400	1.150
51126	130	170	30	1	104 000	350 000	1 300	2 000	1.692
51128	140	180	31	1	107 000	375 000	1 300	1 900	1.940
51130	150	190	31	1	109 000	400 000	1 200	1 900	2.220



Steel Cage



Brass Cage

Bearing No.	Boundary dimensions(mm)			r(mm)	Ca(N)	Coa(N)	Limiting Speed (min-1)		Mass (Kg)
	d	D	T				Grease	Oil	
51132	160	200	31	1	112 000	425 000	1 200	1 800	2.194
51134	170	215	34	1.1	134 000	510 000	1 100	1 700	2.798
51136	180	225	34	1.1	135 000	525 000	1 100	1 600	2.934
51138	190	240	37	1.1	170 000	655 000	1 000	1 500	3.788
51140	200	250	37	1.1	172 000	675 000	1 000	1 500	3.918
51144	220	270	37	1.1	177 000	740 000	970	1 400	4.400
51148	240	300	45	1.5	228 000	935 000	830	1 200	2.100
51152	260	320	45	1.5	232 000	990 000	800	1 200	8.100
51156	280	350	53	1.5	315 000	1 350 000	700	1 000	12.000
51160	300	380	62	2	370 000	1 660 000	610	920	17.500
51164	320	400	63	2	380 000	1 760 000	590	880	18.140
51168	340	420	64	2	385 000	1 860 000	570	850	20.012
51172	360	440	65	2	395 000	1 960 000	550	820	21.300

## Thrust Ball Bearings

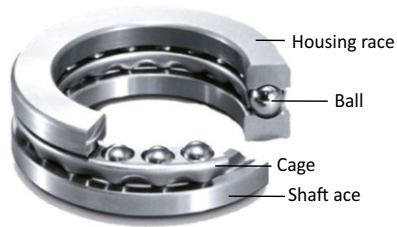
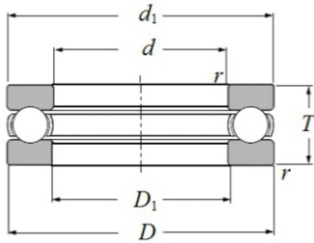

Bearing No.	Boundary dimensions(mm)			r(mm)	Ca(N)	Coa(N)	Limiting Speed (min-1)		Mass (Kg)
	d	D	T				Grease	Oil	
51200	10	26	11	0.6	12 700	17 100	5900	8800	0.030
51201	12	28	11	0.6	13 200	19 000	5600	8500	0.034
51202	15	32	12	0.6	16 600	24 800	5100	7600	0.042
51203	17	35	12	0.6	17 100	27 300	4800	7300	0.052
51204	20	40	14	0.6	22 200	37 500	4200	6300	0.076
51205	25	47	15	0.6	27 800	50 500	3700	5600	0.108
51206	30	52	16	0.6	29 300	58 000	3400	5200	0.132
51207	35	62	18	1	39 000	78 000	2900	4400	0.210
51208	40	68	19	1	47 000	98 500	2700	4100	0.262
51209	45	73	20	1	47 500	105 000	2600	3900	0.308
51210	50	78	22	1	48 500	112 000	2400	3600	0.370
51211	55	90	25	1	69 500	159 000	2100	3100	0.590
51212	60	95	26	1	73 500	179 000	2000	3000	0.668
51213	65	100	27	1	75 000	189 000	1900	2800	0.760
51214	70	105	27	1	76 000	199 000	1800	2800	0.796
51215	75	110	27	1	77 500	209 000	1800	2700	0.834
51216	80	115	28	1	78 500	219 000	1700	2600	0.884
51217	85	125	31	1	95 500	264 000	1600	2400	1.224
51218	90	135	35	1.1	116 000	325 000	1400	2100	1.686
51220	100	150	38	1.1	146 000	410 000	1300	1900	2.220
51222	110	160	38	1.1	152 000	450 000	1200	1900	2.424
51224	120	170	39	1.1	154 000	470 000	1200	1800	2.752
51226	130	190	45	1.5	203 000	620 000	1000	1500	4.180
51228	140	200	46	1.5	205 000	650 000	1000	1500	4.460
51230	150	215	50	1.5	213 000	650 000	940	1400	5.600



Steel Cage



Brass Cage

Bearing No.	Boundary dimensions(mm)			r(mm)	Ca(N)	Coa(N)	Limiting Speed (min-1)		Mass (Kg)
	d	D	T				Grease	Oil	
51232	160	225	51	1.5	223 000	720 000	900	1 300	5.960
51234	170	240	55	1.5	261 000	835 000	840	1 200	7.400
51236	180	250	56	1.5	266 000	875 000	810	1 200	8.600
51238	190	270	62	2	310 000	1 060 000	740	1 100	12.000
51240	200	280	62	2	315 000	1 110 000	720	1 000	12.400
51244	220	300	63	2	325 000	1 210 000	690	1 000	13.700
51248	240	340	78	2.1	430 000	1 730 000	570	860	23.600
51252	260	360	79	2.1	445 000	1 880 000	550	830	25.200
51256	280	380	80	2.1	450 000	1 950 000	530	800	21.500
51260	300	420	95	3	585 000	2 720 000	450	680	41.500
51264	320	440	95	3	595 000	2 830 000	440	660	44.200
51268	340	460	96	3	600 000	2 940 000	430	640	46.800
51272	360	500	110	4	745 000	3 800 000	380	570	68.000

## Thrust Ball Bearings

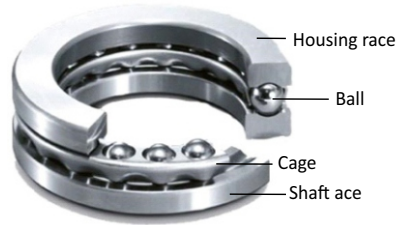
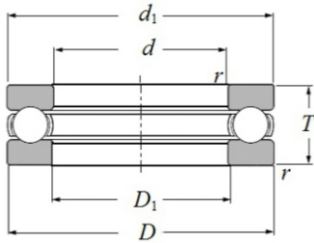

Bearing No.	Boundary dimensions(mm)			r(mm)	Ca(N)	Coa(N)	Limiting Speed (min-1)		Mass (Kg)
	d	D	T				Grease	Oil	
51305	25	52	18	1	35 500	61 500	3 200	4 900	0.168
51306	30	60	21	1	42 500	78 500	2 800	4 200	0.256
51307	35	68	24	1	55 500	105 000	2 400	3 700	0.378
51308	40	78	26	1	69 000	135 000	2 200	3 300	0.534
51309	45	85	28	1	80 000	163 000	2 000	3 000	0.664
51310	50	95	31	1.1	96 500	202 000	1 800	2 700	0.938
51311	55	105	35	1.1	120 000	246 000	1 600	2 400	1.310
51312	60	110	35	1.1	123 000	267 000	1 600	2 400	1.406
51313	65	115	36	1.1	127 000	287 000	1 500	2 300	1.570
51314	70	125	40	1.1	148 000	340 000	1 400	2 100	1.998
51315	75	135	44	1.5	170 000	395 000	1 200	1 900	2.600
51316	80	140	44	1.5	176 000	425 000	1 200	1 800	2.750
51317	85	150	49	1.5	206 000	490 000	1 100	1 700	3.660
51318	90	155	50	1.5	213 000	525 000	1 100	1 600	3.800
51320	100	170	55	1.5	236 000	595 000	1 000	1 500	5.020
51322	110	190	63	2	267 000	705 000	880	1 300	7.850
51324	120	210	70	2.1	310 000	870 000	790	1 100	10.080
51326	130	225	75	2.1	330 000	960 000	730	1 100	11.760
51328	140	240	80	2.1	350 000	1 050 000	680	1 000	14.180
51330	150	250	80	2.1	360 000	1 130 000	670	1 000	15.180
51332	160	270	87	3	410 000	1 340 000	610	920	19.420
51334	170	280	87	3	420 000	1 430 000	600	900	20.480
51336	180	300	95	3	485 000	1 700 000	550	820	28.500
51338	190	320	105	4	570 000	2 100 000	500	750	36.500
51340	200	340	110	4	625 000	2 380 000	470	710	44.500



Steel Cage



Brass Cage

Bearing No.	Boundary dimensions(mm)			r(mm)	Ca(N)	Coa(N)	Limiting Speed (min-1)		Mass (Kg)
	d	D	T				Grease	Oil	
51405	25	60	24	1	55 500	89 500	2 600	3 900	0.340
51406	30	70	28	1	72 500	126 000	2 200	3 300	0.530
51407	35	80	32	1.1	87 000	155 000	1 900	2 900	0.790
51408	40	90	36	1.1	112 000	205 000	1 700	2 600	1.100
51409	45	100	39	1.1	129 000	243 000	1 600	2 400	1.400
51410	50	110	43	1.5	148 000	283 000	1 400	2 100	2.000
51411	55	120	48	1.5	178 000	360 000	1 300	1 900	2.718
51412	60	130	51	1.5	213 000	435 000	1 200	1 800	3.100
51413	65	140	56	2	231 000	495 000	1 100	1 600	4.000
51414	70	150	60	2	250 000	555 000	1 000	1 500	5.056
51415	75	160	65	2	252 000	560 000	950	1 400	6.260
51416	80	170	68	2.1	270 000	620 000	900	1 300	7.360
51417	85	180	72	2.1	288 000	685 000	850	1 200	8.540
51418	90	190	77	2.1	305 000	750 000	790	1 100	10.220
51420	100	210	85	3	345 000	895 000	710	1 000	13.820
51422	110	230	95	3	435 000	1 240 000	640	960	17.880
51424	120	250	102	4	455 000	1 340 000	580	880	23.220
51426	130	270	110	4	555 000	1 750 000	540	810	31.200
51428	140	280	112	4	545 000	1 750 000	520	780	33.600
51430	150	300	120	4	615 000	2 010 000	480	720	40.900
51432	160	320	130	5	680 000	2 410 000	440	670	50.800
51434	170	340	135	5	755 000	2 730 000	420	630	59.300
51436	180	360	140	5	785 000	2 980 000	400	600	69.100

## Thrust Ball Bearings

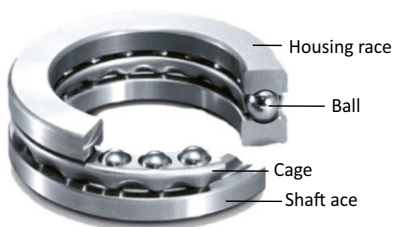
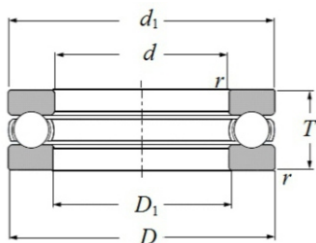

Bearing No.	Boundary dimensions(mm)			r(mm)	Ca(N)	Coa(N)	Limiting Speed (min <sup>-1</sup> )		Mass (Kg)
	d	D	T				Grease	Oil	
2900	10	26	12	0.6	12 700	17 100	5 600	8 400	0.033
2901	12	28	12	0.6	13 200	19 000	5 400	8 100	0.035
2902	15	31	12	0.6	14 300	22 800	5 100	7 700	0.042
2903	18	35	12	0.6	14 400	24 700	4 800	7 300	0.049
2904	20	37	12	0.6	14 800	26 600	4 700	7 100	0.058
2905	25	45	14	0.6	19 300	37 000	3 900	5 900	0.096
2906	30	50	14	0.6	20 200	42 000	3 700	5 600	0.112
2907	35	55	16	0.6	29 900	62 000	3 300	5 000	0.144
2908	40	60	16	0.6	31 000	70 000	3 200	4 800	0.162
2909	45	68	16	0.6	32 500	77 500	3 000	4 500	0.200
2910	50	74	18	0.6	38 500	94 000	2 700	4 100	0.260
2911	55	78	18	0.6	40 000	103 000	2 600	4 000	0.266
2912	60	82	18	0.6	40 500	108 000	2 600	3 900	0.270
2913	65	90	20	0.6	47 500	129 000	2 300	3 500	0.369
2914	70	95	20	0.6	49 000	140 000	2 200	3 400	0.390
2915	75	100	20	0.6	51 000	151 000	2 200	3 300	0.416
2916	80	110	22	0.6	57 000	171 000	2 000	3 000	0.589
2917	85	115	22	0.6	59 000	184 000	1 900	2 900	0.465
2918	90	120	22	0.6	59 500	190 000	1 900	2 900	0.654
2919	95	130	25	0.6	75 500	236 000	1 700	2 600	0.960
2920	100	135	25	0.6	78 000	253 000	1 700	2 500	0.930
2921	105	140	25	0.6	78 500	262 000	1 600	2 500	1.010
2922	110	145	25	0.6	78 000	262 000	1 600	2 400	1.033
2923	115	150	25	0.6	73 500	245 000	1 600	2 400	1.250
2924	120	160	27	0.6	94 000	314 000	1 500	2 200	1.350
2925	125	165	27	0.6	85 500	298 000	1 400	2 200	1.480
2928	140	185	31	0.6	106 000	375 000	1 300	1 900	2.310





Steel Cage



Brass Cage

Bearing No.	Boundary dimensions(mm)			r(mm)	Ca(N)	Coa(N)	Limiting Speed (min-1)		Mass (Kg)
	d	D	T				Grease	Oil	
3905	25	52	16	1	27 100	50 500	3 400	5 200	0.144
3906	30	60	19	1	38 000	72 500	2 900	4 400	0.226
3907	35	68	22	1	50 500	99 000	2 500	3 800	0.342
3908	40	76	25	1	61 000	119 000	2 200	3 400	0.470
3909	45	85	28	1	79 500	163 000	2 000	3 000	0.667
3910	50	92	31	1	97 000	202 000	1 800	2 800	0.869
3911	55	100	33	1	110 000	240 000	1 700	2 600	1.077
3912	60	106	35	1.5	119 000	263 000	1 600	2 400	1.270
3913	65	112	36	1.5	128 000	287 000	1 500	2 300	1.400
3914	70	120	38	1.5	143 000	335 000	1 400	2 200	1.730
3915	75	128	41	1.5	159 000	365 000	1 300	2 000	2.100
3916	80	136	44	1.5	183 000	425 000	1 200	1 900	2.700
3917	85	145	47	1.5	207 000	490 000	1 100	1 700	3.140
3918	90	155	50	1.5	232 000	555 000	1 100	1 600	3.800
3919	95	165	54	1.5	253 000	630 000	1 000	1 500	4.740
3920	100	172	57	1.5	250 000	630 000	980	1 400	5.450
3921	105	180	60	2.5	257 000	670 000	930	1 400	6.250
3922	110	190	63	2.5	293 000	785 000	880	1 300	7.140
3923	115	200	66	2.5	315 000	870 000	840	1 200	8.230
3924	120	210	69	2.5	325 000	930 000	800	1 200	9.970

## Thrust Ball Bearings

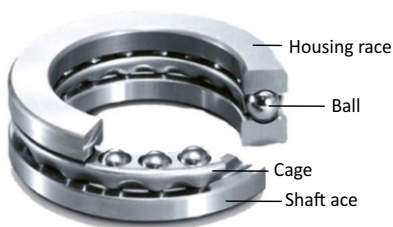
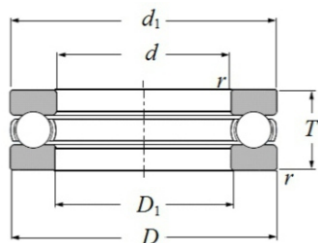

### INC SERIES

Bearing No.	Boundary dimensions(mm)			r(mm)	Ca(N)	Coa(N)	Limiting Speed (min-1)		Mass (Kg)
	d	D	T				Grease	Oil	
O-4	12.700	32.544	15.875	0.8	18 600	25 100	4 300	6 500	0.063
O-5	15.875	35.719	15.875	0.8	19 400	28 300	4 100	6 200	0.072
O-6	19.050	38.894	15.875	0.8	21 400	34 500	4 000	6 000	0.081
O-7	22.225	42.069	15.875	0.8	21 900	37 500	3 800	5 800	0.094
O-8	25.400	45.244	15.875	1.6	22 500	41 000	3 700	5 500	0.101
O-9	28.575	48.419	15.875	1.6	24 100	47 000	3 600	5 400	0.108
O-10	31.750	53.181	18.256	1.6	27 900	54 500	3 200	4 800	0.152
O-11	34.925	56.356	18.256	1.6	28 600	58 000	3 100	4 600	0.163
O-12	38.100	59.531	18.256	1.6	30 500	66 000	3 000	4 500	0.184
O-13	41.275	62.706	18.256	1.6	26 700	63 000	2 900	4 400	0.186
O-14	44.450	68.262	19.050	1.6	32 500	77 500	2 700	4 100	0.230
O-15	47.625	71.438	19.050	1.6	37 500	89 000	2 700	4 000	0.248
O-16	50.800	75.406	19.050	2.4	38 000	94 000	2 600	3 900	0.270
O-17	53.975	81.756	22.225	2.4	49 500	118 000	2 300	3 500	0.310
O-18	57.150	84.931	22.225	2.4	50 500	125 000	2 300	3 400	0.385
O-19	60.325	91.281	25.400	2.4	58 000	145 000	2 000	3 100	0.425
O-20	63.500	94.456	25.400	2.4	59 500	152 000	2 000	3 000	0.577
O-21	66.675	97.631	25.400	2.4	60 500	160 000	2 000	3 000	0.599
O-22	69.850	102.394	25.400	2.4	71 500	179 000	1 900	2 900	0.653
O-23	73.025	105.569	25.400	2.4	75 500	199 000	1 900	2 800	0.769
O-24	76.200	111.125	28.575	3.2	77 000	209 000	1 700	2 600	0.948
O-26	82.550	122.238	31.750	3.2	97 500	252 000	1 600	2 400	1.143
O-28	88.900	128.588	31.750	3.2	99 000	266 000	1 500	2 300	1.230



Steel Cage



Brass Cage

Bearing No.	Boundary dimensions(mm)			r(mm)	Ca(N)	Coa(N)	Limiting Speed (min-1)		Mass (Kg)
	d	D	T				Grease	Oil	
905	25	48	15.5	0.6	27 800	50 500	3 700	5 600	0.120
906	30	53	15.5	0.6	29 300	58 000	3 400	5 200	0.130
907	35	62	18	1	39 000	78 000	2 900	4 400	0.180
908	40	64	18	1	47 000	98 500	2 700	4 100	0.210
909	45	73	22	1	47 500	105 000	2 600	3 900	0.350
910	50	78	22	1	48 500	112 000	2 400	3 600	0.420
911	55	88	24.5	1	69 500	159 000	2 100	3 100	0.510
912	60	90	24.5	1	73 500	179 000	2 000	3 000	0.560
913	65	100	27	1	75 000	189 000	1 900	2 800	0.580
914	70	103	27	1	76 000	199 000	1 800	2 800	0.760
915	75	110	27	1	77 500	209 000	1 800	2 700	1.850
916	80	115	29	1	78 500	219 000	1 700	2 600	1.920

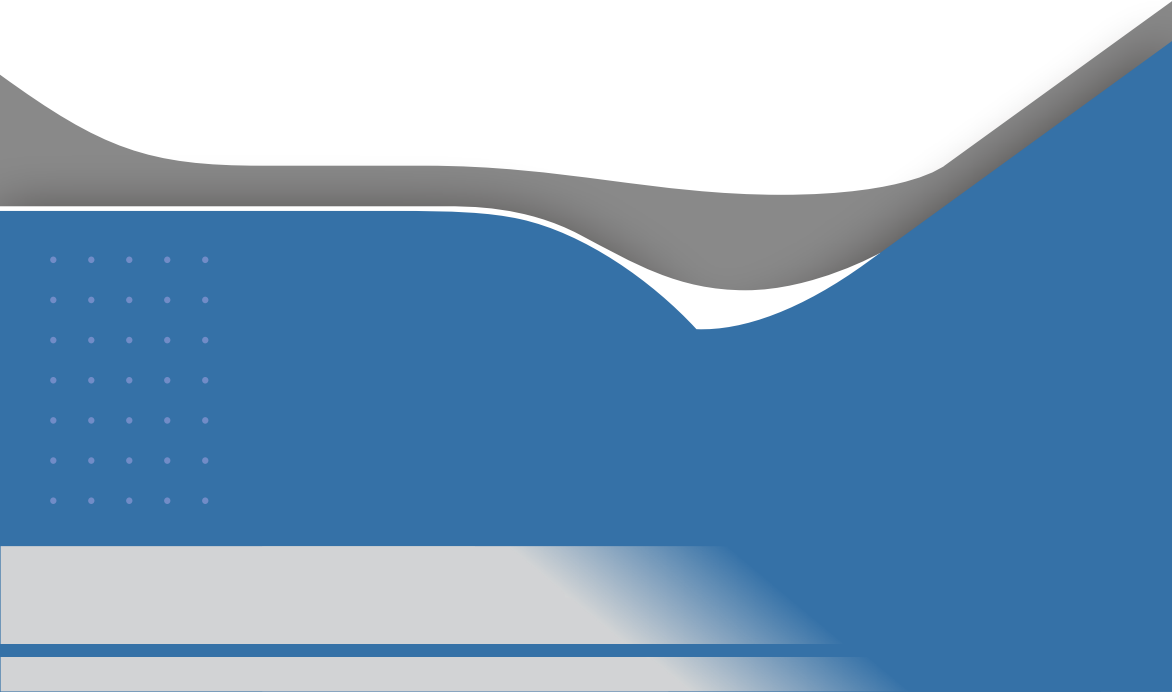

**ASB<sup>®</sup>** | 

**Bearing  
Units** | 

## Insert Bearing Units

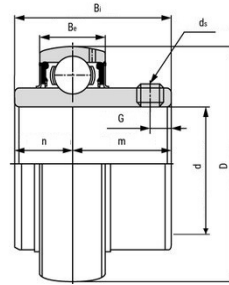

Unit No.	Boundary dimensions(mm)				Basic load rating (N) r	Cr(N)	Cor(N)	Mass (Kg)
	Shaft Dia	D	B1	B2				
UC 201	12	47	31	17	1	12 800	6 600	0.190
UC 201-8	12.700	47	31	17	1	12 800	6 600	0.190
UC 202	15	47	31	17	1	12 800	6 600	0.180
UC 202-10	15.875	47	31	17	1	12 800	6 600	0.180
UC 203	17	47	31	17	1	12 800	6 600	0.170
UC 204	20	47	31	17	1.5	12 800	6 600	0.150
UC 205	25	52	34	17	1.5	14 000	7 900	0.190
UC 205-14	22.225	52	34	17	1.5	14 000	7 900	0.220
UC 205-16	25.400	52	34	17	1.5	14 000	7 900	0.190
UC 206	30	62	38.1	19	1.5	19 600	11 300	0.300
UC 206-18	25.575	62	38.1	19	1.5	19 600	11 300	0.320
UC 207	35	72	42.9	20	2	25 900	15 400	0.450
UC 207-20	31.750	72	42.9	20	2	25 900	15 400	0.500
UC 208	40	80	49.2	21	2	29 300	17 900	0.590
UC 208-24	38.100	80	49.2	21	2	29 300	17 900	0.640
UC 209	45	85	49.2	22	2	33 000	20 500	0.650
UC 209-28	44.450	85	49.2	22	2	33 000	20 500	0.680
UC 210	50	90	51.6	23	2	35 500	23 200	0.740



Unit No.	Boundary dimensions(mm)				Basic load rating (N) r	Cr(N)	Cor(N)	Mass (Kg)
	Shaft Dia	D	B1	B2				
UC 210-30	47.625	90	51.6	23	2	35 500	23 200	0.850
UC 211	55	100	55.6	24	2.5	43 000	29 400	0.960
UC 211-32	50.800	100	55.6	24	2.5	43 000	29 400	1.100
UC 212	60	110	65.1	26	2.5	52 500	36 100	1.380
UC 212-36	57.150	110	65.1	26	2.5	52 500	36 100	1.510
UC 213	65	120	65.1	27	2.5	57 500	40 000	1.670
UC 213-40	63.500	120	65.1	27	2.5	57 500	40 000	1.750
UC 214	70	125	74.6	29	2.5	62 000	44 000	1.950
UC 214-44	69.850	125	74.6	29	2.5	62 000	44 000	1.950
UC 215	75	130	77.8	30	2.5	66 000	48 200	2.140
UC 215-48	76.200	130	77.8	30	2.5	66 000	48 200	2.060
UC 216	80	140	82.6	32	3	72 500	53 000	2.610
UC 216-50	79.3750	140	82.6	32	3	72 500	53 000	2.610
UC 217	85	150	85.7	34	3	83 500	61 800	3.380
UC 217-52	82.550	150	85.7	34	3	83 500	61 800	3.380
UC 218	90	160	96	36	3	95 500	71 400	4.000
UC 218-56	88.900	160	96	36	3	95 500	71 400	4.000

## Insert Bearing Units

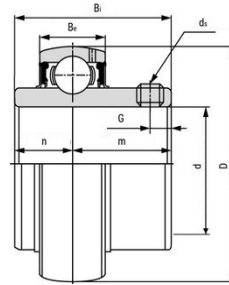

Unit No.	Boundary dimensions(mm)				Basic load rating (N) r	Cr(N)	Cor(N)	Mass (Kg)
	Shaft Dia	D	B1	B2				
UC 305	25	62	38	21	2	21 300	10 900	0.450
UC 305-16	25.400	62	38	21	2	21 300	10 900	0.450
UC 306	30	72	43	23	2	26 800	15 000	0.520
UC 307	35	80	48	25	2.5	33 500	19 200	0.680
UC 308	40	90	52	27	2.5	40 500	23 900	0.950
UC 308-24	38.100	90	52	27	2.5	40 500	23 900	0.950
UC 309	45	100	57	30	2.5	51 500	29 500	1.220
UC 309-28	44.450	100	57	30	2.5	51 500	29 500	1.220
UC 310	50	110	61	32	3	61 500	38 200	1.570
UC 311	55	120	66	34	3	71 500	44 800	1.980
UC 311-32	50.800	120	66	34	3	71 500	44 800	1.980
UC 312	60	130	71	36	3.5	81 500	52 000	2.450
UC 313	65	140	75	38	3.5	92 500	59 700	3.140
UC 313-40	63.500	140	75	38	3.5	92 500	59 700	3.140
UC 314	70	150	78	40	3.5	104 000	68 000	3.620
UC 314-44	69.850	150	78	40	3.5	104 000	68 000	3.620
UC 315	75	160	82	42	3.5	114 000	76 900	4.500
UC 315-47	74.613	160	82	42	3.5	114 000	76 900	4.500
UC 315-48	76.200	160	82	42	3.5	114 000	76 900	4.500
UC 316	80	170	86	44	3.5	123 000	86 400	5.200
UC 317	85	180	96	46	4	132 000	96 500	6.630
UC 318	90	190	96	48	4	143 000	107 200	7.330
UC 318-56	88.900	190	96	48	4	143 000	107 200	7.330
UC 319	95	200	103	50	4	153 000	118 400	8.370
UC 320	100	215	108	54	4	173 000	140 400	10.320
UC 320-64	101.600	215	108	54	4	173 000	140 400	10.320
UC 321	105	225	112	56	4	183 000	153 100	12.700
UC 322	110	240	117	60	4	205 000	178 800	14.000
UC 324	120	260	126	64	4	207 000	184 800	18.000
UC 326	130	280	135	68	5	229 000	214 300	23.600
UC 328	140	300	145	73	5	255 000	246 000	29.400





Unit No.	Boundary dimensions(mm)				Basic load rating (N) r	Cr(N)	Cor(N)	Mass (Kg)
	Shaft Dia	D	B1	B2				
UCX 05	25	62	38.1	19	1.5	19 600	11 300	0.390
UCX 05-16	25.400	62	38.1	19	1.5	19 600	11 300	0.390
UCX 06	30	72	42.9	20	1.5	25 900	15 400	0.580
UCX 06-19	34.925	72	42.9	20	1.5	25 900	15 400	0.580
UCX 06-20	31.750	72	42.9	20	1.5	25 900	15 400	0.550
UCX 07	35	80	49.2	21	2	29 300	17 900	0.750
UCX 07-22	34.925	80	49.2	21	2	29 300	17 900	0.720
UCX 07-23	36.513	80	49.2	21	2	29 300	17 900	0.720
UCX 08	40	85	49.2	22	2	33 000	20 500	0.830
UCX 08-24	38.100	85	49.2	22	2	33 000	20 500	0.870
UCX 09	45	90	51.6	23	2	35 500	23 200	0.950
UCX 09-28	44.450	90	51.6	23	2	35 500	23 200	0.970
UCX 10	50	100	55.6	24	2	43 000	29 400	1.290
UCX 10-31	49.213	100	55.6	24	2	43 000	29 400	1.320
UCX 10-32	50.800	100	55.6	24	2	43 000	29 400	1.260
UCX 11	55	110	65.1	26	2.5	52 500	36 100	1.800
UCX 11-35	55.563	110	65.1	26	2.5	52 500	36 100	1.780
UCX 11-36	57.150	110	65.1	26	2.5	52 500	36 100	1.700

## Insert Bearing Units

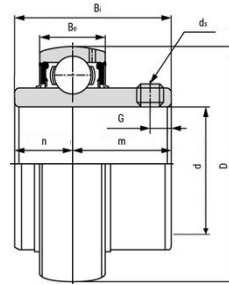

Unit No.	Boundary dimensions(mm)				Basic load rating (N) r	Cr(N)	Cor(N)	Mass (Kg)
	Shaft Dia	D	B1	B2				
UCX 12	60	120	65.1	27	2.5	57 500	40 000	2.050
UCX 12-39	61.913	120	65.1	27	2.5	57 500	40 000	1.950
UCX 13	65	125	74.6	29	2.5	62 000	44 000	2.520
UCX 13-40	63.500	125	74.6	29	2.5	62 000	44 000	2.610
UCX 14	70	130	77.8	30	2.5	66 000	48 200	2.740
UCX 14-44	69.850	130	77.8	30	2.5	66 000	48 200	2.750
UCX 15	75	140	82.6	32	2.5	72 500	53 000	3.410
UCX 15-47	74.613	140	82.6	32	2.5	72 500	53 000	3.430
UCX 15-48	76.200	140	82.6	32	2.5	72 500	53 000	3.320
UCX 16	80	150	85.7	34	3	83 500	61 800	3.870
UCX 17	85	160	96	36	3	95 500	71 400	5.050
UCX 17-55	87.313	160	96	36	3	95 500	71 400	5.050
UCX 18	90	170	104	38	3	109 000	81 600	6.000
UCX 20	100	190	117.5	42	3.5	134 000	104 700	8.560
UCX 20-63	100.013	190	117.5	42	3.5	134 000	104 700	8.560
UCX 20-64	101.600	190	117.5	42	3.5	134 000	104 700	8.560



Unit No.	Boundary dimensions(mm)				Housing	Bearings Brg No.	Cr(N)	Cor(N)	Mass (Kg)
	Shaft Dia	H	H2	L					
UCP 201	12	30.2	62	127	P203	UC201	12 800	6 600	0.610
UCP 201-8	12.700	30.2	62	127	P203	UC201	12 800	6 600	0.600
UCP 202	15	30.2	62	127	P203	UC202	12 800	6 600	0.590
UCP 202-10	15.875	30.2	62	127	P203	UC202	12 800	6 600	0.590
UCP 203	17	30.2	62	127	P203	UC203	12 800	6 600	0.640
UCP 204	20	33.3	65	127	P204	UC204	12 800	6 600	0.610
UCP 204-12	19.050	33.3	65	127	P204	UC204	12 800	6 600	0.620
UCP 205	25	36.5	70	140	P205	UC205	14 000	7 900	0.720
UCP 205-14	22.225	36.5	70	140	P205	UC205	14 000	7 900	0.720
UCP 205-15	23.813	36.5	70	140	P205	UC205	14 000	7 900	0.720
UCP 205-16	25.400	36.5	70	140	P205	UC205	14 000	7 900	0.690
UCP 206	30	42.9	83	165	P206	UC206	19 600	11 300	1.130
UCP 206-19	30.163	42.9	83	165	P206	UC206	19 600	11 300	1.130
UCP 206-20	31.750	42.9	83	165	P206	UC206	19 600	11 300	1.130
UCP 207	35	47.6	94	167	P207	UC207	25 900	15 400	1.340
UCP 207-20	31.750	47.6	94	167	P207	UC207	25 900	15 400	1.390
UCP 207-21	33.338	47.6	94	167	P207	UC207	25 900	15 400	1.390
UCP 207-22	34.925	47.6	94	167	P207	UC207	25 900	15 400	1.390
UCP 207-23	36.513	47.6	94	167	P207	UC207	25 900	15 400	1.390
UCP 208	40	49.2	100	184	P208	UC208	29 300	17 900	1.800
UCP 208-24	38.100	49.2	100	184	P208	UC208	29 300	17 900	1.703
UCP 208-25	39.688	49.2	100	184	P208	UC208	29 300	17 900	1.703
UCP 209	45	54	108	190	P209	UC209	33 000	20 500	1.960
UCP 209-26	41.275	54	108	190	P209	UC209	33 000	20 500	1.960
UCP 209-27	42.863	54	108	190	P209	UC209	33 000	20 500	1.960
UCP 209-28	44.450	54	108	190	P209	UC209	33 000	20 500	2.126

## Pillow Block Bearing Units

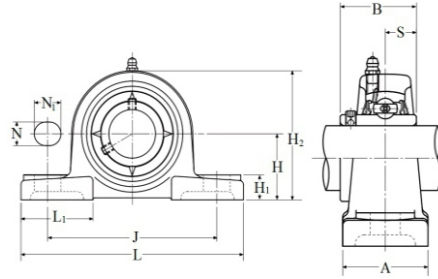

Unit No.	Boundary dimensions(mm)				Housing	Bearings Brg No.	Cr(N)	Cor(N)	Mass (Kg)
	Shaft Dia	H	H2	L					
UCP 210	50	57.2	114	206	P210	UC210	35 500	23 200	2.490
UCP 210-30	47.625	57.2	114	206	P210	UC210	35 500	23 200	2.600
UCP 210-31	49.213	57.2	114	206	P210	UC210	35 500	23 200	2.600
UCP 210-32	50.800	57.2	114	206	P210	UC210	35 500	23 200	2.600
UCP 211	55	63.5	126	219	P211	UC211	43 000	29 400	2.910
UCP 211-32	50.800	63.5	126	219	P211	UC211	43 000	29 400	3.050
UCP 211-34	53.975	63.5	126	219	P211	UC211	43 000	29 400	3.050
UCP 211-35	55.563	63.5	126	219	P211	UC211	43 000	29 400	3.050
UCP 212	60	69.8	138	241	P212	UC212	52 500	36 100	4.440
UCP 212-36	57.150	69.8	138	241	P212	UC212	52 500	36 100	4.110
UCP 212-38	60.325	69.8	138	241	P212	UC212	52 500	36 100	4.110
UCP 212-39	61.913	69.8	138	241	P212	UC212	52 500	36 100	4.110
UCP 213	65	76.2	150	265	P213	UC213	57 500	40 000	5.170
UCP 213-40	63.500	76.2	150	265	P213	UC213	57 500	40 000	5.250
UCP 214	70	79.4	156	266	P214	UC214	62 000	44 000	5.570
UCP 214-44	69.850	79.4	156	266	P214	UC214	62 000	44 000	5.570
UCP 215	75	82.6	163	275	P215	UC215	66 000	48 200	6.140
UCP 215-47	74.613	82.6	163	275	P215	UC215	66 000	48 200	6.140
UCP 215-48	76.200	82.6	163	275	P215	UC215	66 000	48 200	6.060
UCP 216	80	88.9	175	292	P216	UC216	72 500	53 000	7.110
UCP 216-50	79.375	88.9	175	292	P216	UC216	72 500	53 000	7.110
UCP 217	85	95.2	187	310	P217	UC217	83 500	61 800	9.180
UCP 217-52	82.550	95.2	187	310	P217	UC217	83 500	61 800	9.180
UCP 218	90	101.6	200	327	P218	UC218	95 500	71 400	10.630
UCP 218-56	88.900	101.6	200	327	P218	UC218	95 500	71 400	10.630



Unit No.	Boundary dimensions(mm)				Housing	Bearings Brg No.	Cr(N)	Cor(N)	Mass (Kg)
	Shaft Dia	H	H2	L					
UCP 305	25	45	84	175	P305	UC305	21 300	10 900	1.700
UCP 305-16	25.400	45	84	175	P305	UC305	21 300	10 900	1.700
UCP 306	30	50	94	180	P306	UC306	26 800	15 000	1.720
UCP 307	35	56	105	210	P307	UC307	33 500	19 200	2.330
UCP 308	40	60	116	220	P308	UC308	40 500	23 900	3.010
UCP 308-24	38.100	60	116	220	P308	UC308	40 500	23 900	3.010
UCP 309	45	67	128	245	P309	UC309	51 500	29 500	3.770
UCP 309-28	44.450	67	128	245	P309	UC309	51 500	29 500	3.770
UCP 310	50	75	143	275	P310	UC310	61 500	38 200	5.470
UCP 311	55	80	154	310	P311	UC311	71 500	44 800	6.830
UCP 311-32	50.800	80	154	310	P311	UC311	71 500	44 800	8.500
UCP 312	60	85	165	330	P312	UC312	81 500	52 000	8.150
UCP 313	65	90	174	340	P313	UC313	92 500	59 700	9.410
UCP 313-40	63.500	90	174	340	P313	UC313	92 500	59 700	9.410
UCP 314	70	95	186	360	P314	UC314	104 000	68 000	11.080
UCP 314-44	69.850	95	186	360	P314	UC314	104 000	68 000	11.080
UCP 315	75	100	197	380	P315	UC315	114 000	76 900	13.800
UCP 315-47	74.613	100	197	380	P315	UC315	114 000	76 900	13.800
UCP 315-48	76.200	100	197	380	P315	UC315	114 000	76 900	13.080
UCP 316	80	106	209	400	P316	UC316	123 000	86 400	16.200
UCP 317	85	112	221	420	P317	UC317	132 000	96 500	19.520
UCP 318	90	118	233	430	P318	UC318	143 000	107 200	22.160
UCP 318-56	88.900	118	233	430	P318	UC318	143 000	107 200	22.160
UCP 319	95	125	250	470	P319	UC319	153 000	118 400	29.520
UCP 320	100	140	275	490	P320	UC320	173 000	140 400	33.960
UCP 320-63	100.013	140	275	490	P320	UC320	173 000	140 400	33.960
UCP 320-64	101.600	140	275	490	P320	UC320	173 000	140 400	33.960
UCP 321	105	140	278	490	P321	UC321	183 000	153 100	37.600
UCP 322	110	150	295	520	P322	UC322	205 000	178 800	44.000
UCP 324	120	160	321	570	P324	UC324	207 000	184 800	55.000
UCP 326	130	180	354	600	P326	UC326	229 000	214 300	77.020
UCP 328	140	200	388	620	P328	UC328	255 000	246 000	91.660

# Pillow Block Bearing Units

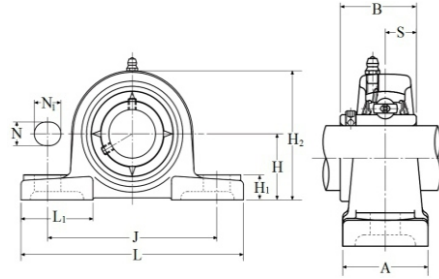

Unit No.	Boundary dimensions(mm)				Housing	Bearings Brg No.	Cr(N)	Cor(N)	Mass (Kg)
	Shaft Dia	H	H2	L					
UCPX 05	25	44.4	85	159	PX05	UCX05	19 600	11 300	1.700
UCPX 05-16	25.400	44.4	85	159	PX05	UCX05	19 600	11 300	1.700
UCPX 06	30	47.6	94	175	PX06	UCX06	25 900	15 400	2.100
UCPX 06-19	30.163	47.6	94	175	PX06	UCX06	25 900	15 400	2.100
UCPX 06-20	31.750	47.6	94	175	PX06	UCX06	25 900	15 400	2.100
UCPX 07	35	54	105	203	PX07	UCX07	29 300	17 900	2.700
UCPX 07-22	34.925	54	105	203	PX07	UCX07	29 300	17 900	2.700
UCPX 07-23	36.513	54	105	203	PX07	UCX07	29 300	17 900	2.700
UCPX 08	40	58.7	113	222	PX08	UCX08	33 000	20 500	3.500
UCPX 08-24	38.100	58.7	113	222	PX08	UCX08	33 000	20 500	3.500
UCPX 09	45	58.7	116	222	PX09	UCX09	35 500	23 200	3.700
UCPX 09-28	44.450	58.7	116	222	PX09	UCX09	35 500	23 200	3.700
UCPX 10	50	63.5	126	241	PX10	UCX10	43 000	29 400	4.600
UCPX 10-31	50.800	63.5	126	241	PX10	UCX10	43 000	29 400	4.600
UCPX 11	55	69.8	139	260	PX11	UCX11	52 500	36 100	6.500
UCPX 11-35	55.563	69.8	139	260	PX11	UCX11	52 500	36 100	6.500
UCPX 11-36	57.150	69.8	139	260	PX11	UCX11	52 500	36 100	6.500
UCPX 12	60	76.2	151	286	PX12	UCX12	57 500	40 000	7.700
UCPX 12-39	61.913	76.2	151	286	PX12	UCX12	57 500	40 000	7.700
UCPX 13	65	76.2	154	286	PX13	UCX13	62 000	44 000	8.100
UCPX 13-40	63.500	76.2	154	286	PX13	UCX13	62 000	44 000	8.100
UCPX 14	70	88.9	172	330	PX14	UCX14	66 000	48 200	10.200
UCPX 14-44	69.850	88.9	172	330	PX14	UCX14	66 000	48 200	10.200
UCPX 15	75	88.9	177	330	PX15	UCX15	72 500	53 000	10.800
UCPX 15-47	74.613	88.9	177	330	PX15	UCX15	72 500	53 000	10.800
UCPX 15-48	76.200	88.9	177	330	PX15	UCX15	72 500	53 000	10.800
UCPX 16	80	101.6	197	381	PX16	UCX16	83 500	61 800	15.300
UCPX 17	85	101.6	202	381	PX17	UCX17	95 500	71 400	16.100
UCPX 17-55	87.313	101.6	202	381	PX17	UCX17	95 500	71 400	16.100
UCPX 18	90	101.6	206	381	PX18	UCX18	109 000	81 600	19.600
UCPX 20	100	127	250	432	PX20	UCX20	134 000	104 700	30.400
UCPX 20-63	100.013	127	250	432	PX20	UCX20	134 000	104 700	30.400
UCPX 20-64	101.600	127	250	432	PX20	UCX20	134 000	104 700	30.400



Unit No.	Boundary dimensions(mm)				Housing	Bearings Brg No.	Cr(N)	Cor(N)	Mass (Kg)
	Shaft Dia	H	H2	L					
UCPH 201	12	70	101	127	PH204	UC201	12 800	6 600	0.960
UCPH 201-8	12.700	70	101	127	PH204	UC201	12 800	6 600	0.960
UCPH 202	15	70	101	127	PH204	UC202	12 800	6 600	0.940
UCPH 202-10	15.875	70	101	127	PH204	UC202	12 800	6 600	0.940
UCPH 203	17	70	101	127	PH204	UC203	12 800	6 600	0.930
UCPH 204	20	70	101	127	PH204	UC204	12 800	6 600	0.910
UCPH 204-12	19.050	70	101	127	PH204	UC204	12 800	6 600	0.910
UCPH 205	25	80	114	140	PH205	UC205	14 000	7 900	1.200
UCPH 205-14	22.225	80	114	140	PH205	UC205	14 000	7 900	1.200
UCPH 205-15	23.813	80	114	140	PH205	UC205	14 000	7 900	1.200
UCPH 205-16	25.400	80	114	140	PH205	UC205	14 000	7 900	1.200
UCPH 206	30	90	130	165	PH206	UC206	19 600	11 300	1.600
UCPH 206-18	28.575	90	130	165	PH206	UC206	19 600	11 300	1.600
UCPH 206-19	30.163	90	130	165	PH206	UC206	19 600	11 300	1.600
UCPH 206-20	31.750	90	130	165	PH206	UC206	19 600	11 300	1.600
UCPH 207	35	95	140	167	PH207	UC207	25 900	15 400	2.000
UCPH 207-20	31.750	95	140	167	PH207	UC207	25 900	15 400	2.000
UCPH 207-21	33.338	95	140	167	PH207	UC207	25 900	15 400	2.000
UCPH 207-22	34.925	95	140	167	PH207	UC207	25 900	15 400	2.000
UCPH 207-23	36.513	95	140	167	PH207	UC207	25 900	15 400	2.000
UCPH 208	40	100	149	184	PH208	UC208	29 300	17 900	2.700
UCPH 208-24	38.100	100	149	184	PH208	UC208	29 300	17 900	2.760
UCPH 208-25	39.688	100	149	184	PH208	UC208	29 300	17 900	2.760
UCPH 209	45	105	157	190	PH209	UC209	33 000	20 500	3.000
UCPH 209-26	41.275	105	157	190	PH209	UC209	33 000	20 500	3.000
UCPH 209-27	42.863	105	157	190	PH209	UC209	33 000	20 500	3.000
UCPH 209-28	44.450	105	157	190	PH209	UC209	33 000	20 500	3.000
UCPH 210	50	110	165	206	PH210	UC210	35 500	23 200	3.500
UCPH 210-30	47.625	110	165	206	PH210	UC210	35 500	23 200	3.500
UCPH 210-31	49.213	110	165	206	PH210	UC210	35 500	23 200	3.500
UCPH 210-32	50.800	110	165	206	PH210	UC210	35 500	23 200	3.500

## Pillow Block Bearing Units

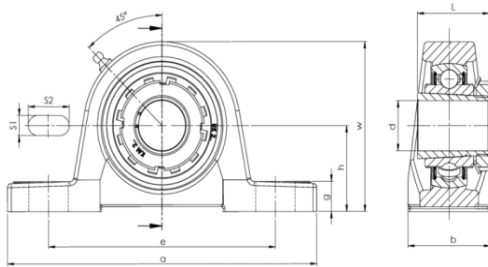

Unit No.	Boundary dimensions(mm)				Housing	Bearings Brg No.	Cr(N)	Cor(N)	Mass (Kg)
	Shaft Dia	h	W	a					
UKP 205	20	36.5	70	140	P205	UK205+H2305	14 000	7 900	0.840
UKP 206	25	42.9	83	165	P206	UK206+H2306	19 600	11 300	1.120
UKP 207	30	47.6	94	167	P207	UK207+H2307	25 900	15 400	1.310
UKP 208	35	49.2	100	184	P208	UK208+H2308	29 300	17 900	1.634
UKP 209	40	54	108	190	P209	UK209+H2309	33 000	20 500	1.935
UKP 210	45	57.2	114	206	P210	UK210+H2310	35 500	23 200	2.354
UKP 211	50	63.5	126	219	P211	UK211+H2311	43 000	29 400	2.700
UKP 212	55	69.8	138	241	P212	UK212+H2312	52 500	36 100	4.340
UKP 213	60	76.2	150	265	P213	UK213+H2313	57 500	40 000	4.800
UKP 215	65	82.6	163	275	P215	UK215+H2315	66 000	48 200	5.640
UKP 216	70	88.9	175	292	P216	UK216+H2316	72 500	53 000	6.920
UKP 217	75	95.2	187	310	P217	UK217+H2317	83 500	61 800	8.440
UKP 218	80	101.6	200	327	P218	UK218+H2318	95 500	71 400	9.900





Unit No.	Boundary dimensions(mm)				Housing	Bearings Brg No.	Cr(N)	Cor(N)	Mass (Kg)
	Shaft Dia	h	W	a					
UKP 305	20	45	84	175	P305	UK305+H2305	21 300	10 900	1.700
UKP 306	25	50	94	180	P306	UK306+H2306	26 800	15 000	2.300
UKP 307	30	56	105	210	P307	UK307+H2307	33 500	19 200	3.000
UKP 308	35	60	116	220	P308	UK308+H2308	40 500	23 900	3.313
UKP 309	40	67	128	245	P309	UK309+H2309	51 500	29 500	4.660
UKP 310	45	75	143	275	P310	UK310+H2310	61 500	38 200	5.570
UKP 311	50	80	154	310	P311	UK311+H2311	71 500	44 800	7.920
UKP 312	55	85	165	330	P312	UK312+H2312	81 500	52 000	8.240
UKP 313	60	90	174	340	P313	UK313+H2313	92 500	59 700	9.720
UKP 315	65	100	197	380	P315	UK315+H2315	114 000	76 900	13.560
UKP 316	70	106	209	400	P316	UK316+H2316	123 000	86 400	15.620
UKP 317	75	112	221	420	P317	UK317+H2317	132 000	96 500	17.920
UKP 318	80	118	233	430	P318	UK318+H2318	143 000	107 200	20.560
UKP 319	85	125	250	470	P319	UK319+H2319	153 000	118 400	27.840
UKP 320	90	140	275	490	P320	UK320+H2320	173 000	140 400	31.920
UKP 322	100	150	295	520	P322	UK322+H2322	205 000	178 800	41.160
UKP 324	110	160	321	570	P324	UK324+H2324	207 000	184 800	53.840
UKP 326	115	180	354	600	P326	UK326+H2326	229 000	214 300	72.440
UKP 328	125	200	388	620	P328	UK328+H2328	255 000	246 000	91.320

## Square Flange Bearing Units

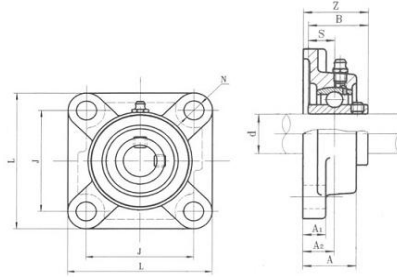

Unit No.	Boundary dimensions(mm)				Housing	Bearings Brg No.	Cr(N)	Cor(N)	Mass (Kg)
	Shaft Dia	L	J	B					
UCF 201	12	86	64	31	F204	UC201	12 800	6 600	0.590
UCF 201-8	12.700	86	64	31	F204	UC201	12 800	6 600	0.590
UCF 202	15	86	64	31	F204	UC202	12 800	6 600	0.570
UCF 202-10	15.875	86	64	31	F204	UC202	12 800	6 600	0.570
UCF 203	17	86	64	31	F204	UC203	12 800	6 600	0.560
UCF 204	20	86	64	31	F204	UC204	12 800	6 600	0.540
UCF 204-12	19.050	86	64	31	F204	UC204	12 800	6 600	0.550
UCF 205	25	95	70	34	F205	UC205	14 000	7 900	0.660
UCF 205-14	22.225	95	70	34	F205	UC205	14 000	7 900	0.690
UCF 205-15	23.813	95	70	34	F205	UC205	14 000	7 900	0.690
UCF 205-16	25.400	95	70	34	F205	UC205	14 000	7 900	0.660
UCF 206	30	108	83	38.1	F206	UC206	19 600	11 300	0.930
UCF 206-18	28.575	108	83	38.1	F206	UC206	19 600	11 300	0.950
UCF 206-19	30.163	108	83	38.1	F206	UC206	19 600	11 300	0.950
UCF 206-20	31.750	108	83	38.1	F206	UC206	19 600	11 300	0.950
UCF 207	35	117	92	42.9	F207	UC207	25 900	15 400	1.200
UCF 207-20	31.750	117	92	42.9	F207	UC207	25 900	15 400	1.380
UCF 207-21	33.338	117	92	42.9	F207	UC207	25 900	15 400	1.380
UCF 207-22	34.925	117	92	42.9	F207	UC207	25 900	15 400	1.380
UCF 207-23	36.513	117	92	42.9	F207	UC207	25 900	15 400	1.380
UCF 208	40	130	102	49.2	F208	UC208	29 300	17 900	1.570
UCF 208-24	38.100	130	102	49.2	F208	UC208	29 300	17 900	1.720
UCF 208-25	39.688	130	102	49.2	F208	UC208	29 300	17 900	1.720
UCF 209	45	137	105	49.2	F209	UC209	33 000	20 500	1.760
UCF 209-26	41.275	137	105	49.2	F209	UC209	33 000	20 500	1.760
UCF 209-27	42.863	137	105	49.2	F209	UC209	33 000	20 500	1.760



Unit No.	Boundary dimensions(mm)				Housing	Bearings Brg No.	Cr(N)	Cor(N)	Mass (Kg)
	Shaft Dia	L	J	B					
UCF 209-28	44.450	137	105	49.2	F209	UC209	33 000	20 500	1.790
UCF 210	50	143	111	51.6	F210	UC210	35 500	23 200	2.050
UCF 210-30	47.625	143	111	51.6	F210	UC210	35 500	23 200	2.160
UCF 210-31	49.213	143	111	51.6	F210	UC210	35 500	23 200	2.160
UCF 210-32	50.800	143	111	51.6	F210	UC210	35 500	23 200	2.160
UCF 211	55	162	130	55.6	F211	UC211	43 000	29 400	2.960
UCF 211-32	50.800	162	130	55.6	F211	UC211	43 000	29 400	3.100
UCF 211-34	53.975	162	130	55.6	F211	UC211	43 000	29 400	3.100
UCF 211-35	55.563	162	130	55.6	F211	UC211	43 000	29 400	3.100
UCF 212	60	175	143	65.1	F212	UC212	52 500	36 100	3.540
UCF 212-36	57.150	175	143	65.1	F212	UC212	52 500	36 100	3.670
UCF 212-38	60.325	175	143	65.1	F212	UC212	52 500	36 100	3.670
UCF 212-39	61.913	175	143	65.1	F212	UC212	52 500	36 100	3.670
UCF 213	65	187	149	65.1	F213	UC213	57 500	40 000	4.920
UCF 213-40	63.500	187	149	65.1	F213	UC213	57 500	40 000	5.000
UCF 214	70	193	152	74.6	F214	UC214	62 000	44 000	5.090
UCF 214-44	69.850	193	152	74.6	F214	UC214	62 000	44 000	5.090
UCF 215	75	200	159	77.8	F215	UC215	66 000	48 200	5.790
UCF 215-47	74.613	200	159	77.8	F215	UC215	66 000	48 200	5.790
UCF 215-48	76.200	200	159	77.8	F215	UC215	66 000	48 200	5.710
UCF 216	80	208	165	82.6	F216	UC216	72 500	53 000	6.910
UCF 216-50	79.375	208	165	82.6	F216	UC216	72 500	53 000	6.910
UCF 217	85	220	175	85.7	F217	UC217	83 500	61 800	8.630
UCF 217-52	82.550	220	175	85.7	F217	UC217	83 500	61 800	8.630
UCF 218	90	235	187	96	F218	UC218	95 500	71 400	9.500
UCF 218-56	88.900	235	187	96	F218	UC218	95 500	71 400	9.500

## Square Flange Bearing Units

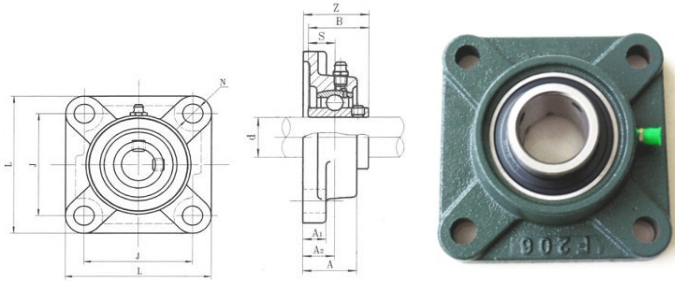

Unit No.	Boundary dimensions(mm)				Housing	Bearings Brg No.	Cr(N)	Cor(N)	Mass (Kg)
	Shaft Dia	L	J	B					
UCF 305	25	110	80	38	F305	UC305	21 300	10 900	1.300
UCF 305-16	25.400	110	80	38	F305	UC305	21 300	10 900	1.300
UCF 306	30	125	95	43	F306	UC306	26 800	15 000	1.480
UCF 307	35	135	100	48	F307	UC307	33 500	19 200	2.300
UCF 308	40	150	112	52	F308	UC308	40 500	23 900	3.220
UCF 308-24	38.100	150	112	52	F308	UC308	40 500	23 900	3.220
UCF 309	45	160	125	57	F309	UC309	51 500	29 500	4.000
UCF 309-28	44.450	160	125	57	F309	UC309	51 500	29 500	4.000
UCF 310	50	175	132	61	F310	UC310	61 500	38 200	4.190
UCF 311	55	185	140	66	F311	UC311	71 500	44 800	6.055
UCF 312	60	195	150	71	F312	UC312	81 500	52 000	6.910
UCF 313	65	208	166	75	F313	UC313	92 500	59 700	7.800
UCF 313-40	63.500	208	166	75	F313	UC313	92 500	59 700	7.800
UCF 314	70	226	178	78	F314	UC314	104 000	68 000	9.880
UCF 314-44	69.850	226	178	78	F314	UC314	104 000	68 000	9.880
UCF 315	75	236	184	82	F315	UC315	114 000	76 900	11.420
UCF 315-47	74.613	236	184	82	F315	UC315	114 000	76 900	11.420
UCF 315-48	76.200	236	184	82	F315	UC315	114 000	76 900	11.420
UCF 316	80	250	196	86	F316	UC316	123 000	86 400	13.240
UCF 317	85	260	204	96	F317	UC317	132 000	96 500	15.240
UCF 318	90	280	216	96	F318	UC318	143 000	107 200	18.120
UCF 318-56	88.900	280	216	96	F318	UC318	143 000	107 200	18.120
UCF 319	95	290	228	103	F319	UC319	153 000	118 400	21.600
UCF 320	100	310	242	108	F320	UC320	173 000	140 400	25.180
UCF 320-63	100.013	310	242	108	F320	UC320	173 000	140 400	25.180
UCF 320-64	101.600	310	242	108	F320	UC320	173 000	140 400	25.180
UCF 321	105	310	242	112	F321	UC321	183 000	153 100	30.200
UCF 322	110	340	266	117	F322	UC322	205 000	178 800	37.000
UCF 324	120	370	290	126	F324	UC324	207 000	184 800	46.000
UCF 326	130	410	320	135	F326	UC326	229 000	214 300	65.500
UCF 328	140	450	350	145	F328	UC328	255 000	246 000	93.400

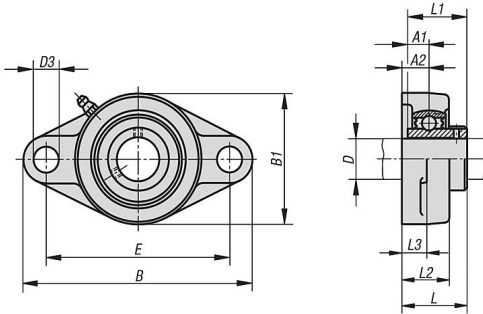

Oval Flange Bearing Units

Unit No.	Boundary dimensions(mm)				Housing	Bearings Brg No.	Cr(N)	Cor(N)	Mass (Kg)
	Shaft Dia	B	B1	L					
UCFL 201	12	113	60	31	FL204	UC201	12 800	6 600	0.440
UCFL 201-8	12.700	113	60	31	FL204	UC201	12 800	6 600	0.440
UCFL 202	15	113	60	31	FL204	UC202	12 800	6 600	0.420
UCFL 202-10	15.875	113	60	31	FL204	UC202	12 800	6 600	0.420
UCFL 203	17	113	60	31	FL204	UC203	12 800	6 600	0.410
UCFL 204	20	113	60	31	FL204	UC204	12 800	6 600	0.390
UCFL 204-12	19.050	113	60	31	FL204	UC204	12 800	6 600	0.400
UCFL 205	25	130	68	34	FL205	UC205	14 000	7 900	0.570
UCFL 205-14	22.225	130	68	34	FL205	UC205	14 000	7 900	0.600
UCFL 205-15	23.813	130	68	34	FL205	UC205	14 000	7 900	0.600
UCFL 205-16	25.400	130	68	34	FL205	UC205	14 000	7 900	0.570
UCFL 206	30	148	80	38.1	FL206	UC206	19 600	11 300	0.760
UCFL 206-18	28.575	148	80	38.1	FL206	UC206	19 600	11 300	0.780
UCFL 206-19	30.163	148	80	38.1	FL206	UC206	19 600	11 300	0.780
UCFL 206-20	31.750	148	80	38.1	FL206	UC206	19 600	11 300	0.780
UCFL 207	35	161	90	42.9	FL207	UC207	25 900	15 400	1.050
UCFL 207-20	31.750	161	90	42.9	FL207	UC207	25 900	15 400	1.100
UCFL 207-21	33.338	161	90	42.9	FL207	UC207	25 900	15 400	1.100
UCFL 207-22	34.925	161	90	42.9	FL207	UC207	25 900	15 400	1.100
UCFL 207-23	36.513	161	90	42.9	FL207	UC207	25 900	15 400	1.100
UCFL 208	40	175	100	49.2	FL208	UC208	29 300	17 900	1.340
UCFL 208-24	38.100	175	100	49.2	FL208	UC208	29 300	17 900	1.390
UCFL 208-25	39.688	175	100	49.2	FL208	UC208	29 300	17 900	1.390
UCFL 209	45	188	108	49.2	FL209	UC209	33 000	20 500	1.700
UCFL 209-26	41.275	188	108	49.2	FL209	UC209	33 000	20 500	1.700
UCFL 209-27	42.863	188	108	49.2	FL209	UC209	33 000	20 500	1.700

## Oval Flange Bearing Units

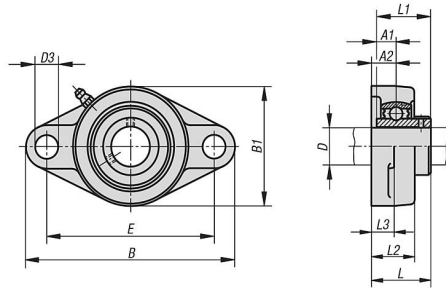

Unit No.	Boundary dimensions(mm)				Housing	Bearings Brg No.	Cr(N)	Cor(N)	Mass (Kg)
	Shaft Dia	B	B1	L					
UCFL 209-28	44.450	188	108	49.2	FL209	UC209	33 000	20 500	1.730
UCFL 210	50	197	115	51.6	FL210	UC210	35 500	23 200	1.920
UCFL 210-30	47.625	197	115	51.6	FL210	UC210	35 500	23 200	1.920
UCFL 210-31	49.213	197	115	51.6	FL210	UC210	35 500	23 200	1.920
UCFL 210-32	50.800	197	115	51.6	FL210	UC210	35 500	23 200	1.920
UCFL 211	55	224	130	55.6	FL211	UC211	43 000	29 400	2.730
UCFL 211-32	50.800	224	130	55.6	FL211	UC211	43 000	29 400	2.870
UCFL 211-34	53.975	224	130	55.6	FL211	UC211	43 000	29 400	2.870
UCFL 211-35	55.563	224	130	55.6	FL211	UC211	43 000	29 400	2.870
UCFL 212	60	250	140	65.1	FL212	UC212	52 500	36 100	3.560
UCFL 212-36	57.150	250	140	65.1	FL212	UC212	52 500	36 100	3.690
UCFL 212-38	60.325	250	140	65.1	FL212	UC212	52 500	36 100	3.690
UCFL 212-39	61.913	250	140	65.1	FL212	UC212	52 500	36 100	3.690
UCFL 213	65	258	155	65.1	FL213	UC213	57 500	40 000	4.450
UCFL 213-40	63.500	258	155	65.1	FL213	UC213	57 500	40 000	4.450
UCFL 214	70	265	160	74.6	FL214	UC214	62 000	44 000	5.700
UCFL 214-44	69.850	265	160	74.6	FL214	UC214	62 000	44 000	5.700
UCFL 215	75	275	165	77.8	FL215	UC215	66 000	48 200	6.400
UCFL 215-47	74.613	275	165	77.8	FL215	UC215	66 000	48 200	6.400
UCFL 215-48	76.200	275	165	77.8	FL215	UC215	66 000	48 200	6.400
UCFL 216	80	290	180	82.6	FL216	UC216	72 500	53 000	7.800
UCFL 216-50	79.375	290	180	82.6	FL216	UC216	72 500	53 000	7.800
UCFL 217	85	305	190	85.7	FL217	UC217	83 500	61 800	9.800
UCFL 217-52	82.550	305	190	85.7	FL217	UC217	83 500	61 800	9.800
UCFL 218	90	320	205	96	FL218	UC218	95 500	71 400	12.300
UCFL 218-56	88.900	320	205	96	FL218	UC218	95 500	71 400	12.300



Unit No.	Boundary dimensions(mm)				Housing	Bearings Brg No.	Cr(N)	Cor(N)	Mass (Kg)
	Shaft Dia	B	B1	L					
UCFL 305	25	150	80	38	FL305	UC305	21 300	10 900	1.100
UCFL 305-16	25.400	150	80	38	FL305	UC305	21 300	10 900	1.100
UCFL 306	30	180	90	43	FL306	UC306	26 800	15 000	1.500
UCFL 307	35	185	100	48	FL307	UC307	33 500	19 200	1.800
UCFL 308	40	200	112	52	FL308	UC308	40 500	23 900	2.500
UCFL 308-24	38.100	200	112	52	FL308	UC308	40 500	23 900	2.500
UCFL 309	45	230	125	57	FL309	UC309	51 500	29 500	3.500
UCFL 309-28	44.450	230	125	57	FL309	UC309	51 500	29 500	3.500
UCFL 310	50	240	140	61	FL310	UC310	61 500	38 200	4.400
UCFL 311	55	250	150	66	FL311	UC311	71 500	44 800	5.300
UCFL 311-32	50.800	250	150	66	FL311	UC311	71 500	44 800	5.300
UCFL 312	60	270	160	71	FL312	UC312	81 500	52 000	6.500
UCFL 313	65	295	175	75	FL313	UC313	92 500	59 700	8.500
UCFL 313-40	63.500	295	175	75	FL313	UC313	92 500	59 700	8.500
UCFL 314	70	315	185	78	FL314	UC314	104 000	68 000	9.700
UCFL 314-44	69.850	315	185	78	FL314	UC314	104 000	68 000	9.700
UCFL 315	75	320	195	82	FL315	UC315	114 000	76 900	10.000
UCFL 315-47	74.613	320	195	82	FL315	UC315	114 000	76 900	10.000
UCFL 315-48	76.200	320	195	82	FL315	UC315	114 000	76 900	10.000
UCFL 316	80	355	210	86	FL316	UC316	123 000	86 400	14.400
UCFL 317	80	370	220	96	FL317	UC317	132 000	96 500	16.000
UCFL 318	90	385	235	96	FL318	UC318	143 000	107 200	19.000
UCFL 318-56	88.900	385	235	96	FL318	UC318	143 000	107 200	19.000
UCFL 319	95	405	250	103	FL319	UC319	153 000	118 400	24.600
UCFL 320	100	440	270	108	FL320	UC320	173 000	140 400	29.400
UCFL 320-63	100.013	440	270	108	FL320	UC320	173 000	140 400	29.400
UCFL 320-64	101.600	440	270	108	FL320	UC320	173 000	140 400	29.400
UCFL 321	105	440	270	112	FL321	UC321	183 000	153 100	30.900
UCFL 322	110	470	300	117	FL322	UC322	205 000	178 800	36.200
UCFL 324	120	520	330	126	FL324	UC324	207 000	184 800	51.500
UCFL 326	130	550	360	135	FL326	UC326	229 000	214 300	61.600
UCFL 328	140	600	400	145	FL328	UC328	255 000	246 000	78.100

## Take Up Bearing Units

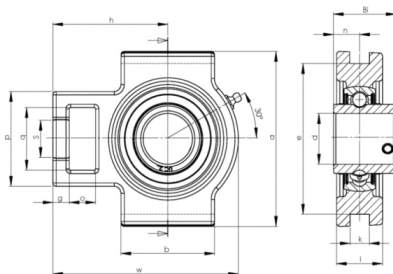

Unit No.	Boundary dimensions(mm)				Housing	Bearings Brg No.	Cr(N)	Cor(N)	Mass (Kg)
	Shaft Dia	a	h	B1					
UCT 201	12	89	94	31	T204	UC201	12 800	6 600	0.750
UCT 201-8	12.700	89	94	31	T204	UC201	12 800	6 600	0.750
UCT 202	15	89	94	31	T204	UC202	12 800	6 600	0.730
UCT 202-10	15.875	89	94	31	T204	UC202	12 800	6 600	0.730
UCT 203	17	89	94	31	T204	UC203	12 800	6 600	0.720
UCT 204	20	89	94	31	T204	UC204	12 800	6 600	0.700
UCT 204-12	20	89	94	31	T204	UC204	12 800	6 600	0.710
UCT 205	25	89	97	34	T205	UC205	14 000	7 900	0.730
UCT 205-14	22.225	89	97	34	T205	UC205	14 000	7 900	0.760
UCT 205-15	23.813	89	97	34	T205	UC205	14 000	7 900	0.760
UCT 205-16	25.400	89	97	34	T205	UC205	14 000	7 900	0.730
UCT 206	30	102	113	38.1	T206	UC206	19 600	11 300	1.170
UCT 206-18	28.575	102	113	38.1	T206	UC206	19 600	11 300	1.190
UCT 206-19	30.163	102	113	38.1	T206	UC206	19 600	11 300	1.190
UCT 206-20	31.750	102	113	38.1	T206	UC206	19 600	11 300	1.190
UCT 207	35	102	129	42.9	T207	UC207	25 900	15 400	1.450
UCT 207-20	31.750	102	129	42.9	T207	UC207	25 900	15 400	1.500
UCT 207-21	33.338	102	129	42.9	T207	UC207	25 900	15 400	1.500
UCT 207-22	34.925	102	129	42.9	T207	UC207	25 900	15 400	1.500
UCT 207-23	36.513	102	129	42.9	T207	UC207	25 900	15 400	1.500
UCT 208	40	114	144	49.2	T208	UC208	29 300	17 900	2.110
UCT 208-24	38.100	114	144	49.2	T208	UC208	29 300	17 900	2.160
UCT 208-25	39.688	114	144	49.2	T208	UC208	29 300	17 900	2.160
UCT 209	45	117	144	49.2	T209	UC209	33 000	20 500	2.180
UCT 209-26	41.275	117	144	49.2	T209	UC209	33 000	20 500	2.180
UCT 209-27	42.863	117	144	49.2	T209	UC209	33 000	20 500	2.180





Unit No.	Boundary dimensions(mm)				Housing	Bearings Brg No.	Cr(N)	Cor(N)	Mass (Kg)
	Shaft Dia	a	h	B1					
UCT 209-28	44.450	117	144	49.2	T209	UC209	33 000	20 500	2.210
UCT 210	50	117	149	51.6	T210	UC210	35 500	23 200	2.350
UCT 210-30	47.625	117	149	51.6	T210	UC210	35 500	23 200	2.460
UCT 210-31	49.213	117	149	51.6	T210	UC210	35 500	23 200	2.460
UCT 210-32	50.800	117	149	51.6	T210	UC210	35 500	23 200	2.460
UCT 211	55	146	171	55.6	T211	UC211	43 000	29 400	3.560
UCT 211-32	50.800	146	171	55.6	T211	UC211	43 000	29 400	3.700
UCT 211-34	53.975	146	171	55.6	T211	UC211	43 000	29 400	3.700
UCT 211-35	55.563	146	171	55.6	T211	UC211	43 000	29 400	3.700
UCT 212	60	146	194	65.1	T212	UC212	52 500	36 100	4.230
UCT 212-36	57.150	146	194	65.1	T212	UC212	52 500	36 100	4.360
UCT 212-38	60.325	146	194	65.1	T212	UC212	52 500	36 100	4.360
UCT 212-39	61.913	146	194	65.1	T212	UC212	52 500	36 100	4.360
UCT 213	65	167	224	65.1	T213	UC213	57 500	40 000	6.040
UCT 213-40	63.500	167	224	65.1	T213	UC213	57 500	40 000	6.120
UCT 214	70	167	224	74.6	T214	UC214	62 000	44 000	6.350
UCT 214-44	69.850	167	224	74.6	T214	UC214	62 000	44 000	6.350
UCT 215	75	167	232	77.8	T215	UC215	66 000	48 200	6.600
UCT 215-47	74.613	167	232	77.8	T215	UC215	66 000	48 200	6.600
UCT 215-48	76.200	167	232	77.8	T215	UC215	66 000	48 200	6.520
UCT 216	80	184	235	82.6	T216	UC216	72 500	53 000	7.240
UCT 216-50	79.375	184	235	82.6	T216	UC216	72 500	53 000	7.240
UCT 217	85	198	260	85.7	T217	UC217	83 500	61 800	10.330
UCT 217-52	82.550	198	260	85.7	T217	UC217	83 500	61 800	10.330
UCT 218	90	215	275	88.4	T218	UC218	95 500	71 400	11.800

## Take Up Bearing Units

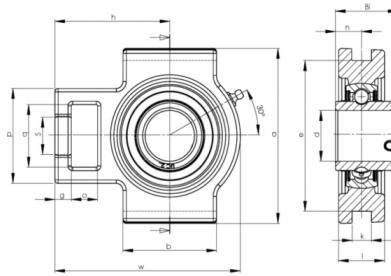

Unit No.	Boundary dimensions(mm)				Housing	Bearings Brg No.	Cr(N)	Cor(N)	Mass (Kg)
	Shaft Dia	B	B1	L					
UCT 305	25	89	122	38	T305	UC305	21 300	10 900	1.400
UCT 305-16	25.400	89	122	38	T305	UC305	21 300	10 900	1.400
UCT 306	30	100	137	43	T306	UC306	26 800	15 000	1.800
UCT 307	35	111	150	48	T307	UC307	33 500	19 200	2.300
UCT 308	40	124	162	52	T308	UC308	40 500	23 900	3.000
UCT 308-24	38.100	124	162	52	T308	UC308	40 500	23 900	3.000
UCT 309	45	138	178	57	T309	UC309	51 500	29 500	4.100
UCT 309-28	44.450	138	178	57	T309	UC309	51 500	29 500	4.100
UCT 310	50	151	191	61	T310	UC310	61 500	38 200	4.900
UCT 311	55	163	207	66	T311	UC311	71 500	44 800	6.100
UCT 311-32	50.800	163	207	66	T311	UC311	71 500	44 800	6.100
UCT 312	60	178	220	71	T312	UC312	81 500	52 000	7.600
UCT 313	65	190	238	75	T313	UC313	92 500	59 700	9.300
UCT 313-40	63.500	190	238	75	T313	UC313	92 500	59 700	9.300
UCT 314	70	202	252	78	T314	UC314	104 000	68 000	11.100
UCT 314-44	69.850	202	252	78	T314	UC314	104 000	68 000	11.100



Unit No.	Boundary dimensions(mm)				Housing	Bearings Brg No.	Cr(N)	Cor(N)	Mass (Kg)
	Shaft Dia	B	B1	L					
UCT 315	75	216	262	82	T315	UC315	114 000	76 900	13.000
UCT 315-47	74.613	216	262	82	T315	UC315	114 000	76 900	13.000
UCT 315-48	76.200	216	262	82	T315	UC315	114 000	76 900	13.000
UCT 316	80	230	282	86	T316	UC316	123 000	86 400	16.200
UCT 317	85	240	298	96	T317	UC317	132 000	96 500	19.000
UCT 318	90	255	312	96	T318	UC318	143 000	107 200	21.280
UCT 318-56	88.900	255	312	96	T318	UC318	143 000	107 200	21.280
UCT 319	95	270	322	103	T319	UC319	153 000	118 400	24.900
UCT 320	100	290	345	108	T320	UC320	173 000	140 400	30.700
UCT 320-63	100.013	290	345	108	T320	UC320	173 000	140 400	30.700
UCT 320-64	101.600	290	345	108	T320	UC320	173 000	140 400	30.700
UCT 321	105	290	345	112	T321	UC321	183 000	153 100	36.700
UCT 322	110	320	385	117	T322	UC322	205 000	178 800	39.000
UCT 324	120	355	432	126	T324	UC324	207 000	184 800	54.000
UCT 326	130	385	465	135	T326	UC326	229 000	214 300	69.300
UCT 328	140	415	515	145	T328	UC328	255 000	246 000	85.100

## Light Series Pillow Block Bearing Units

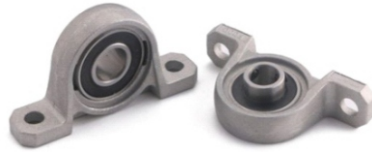
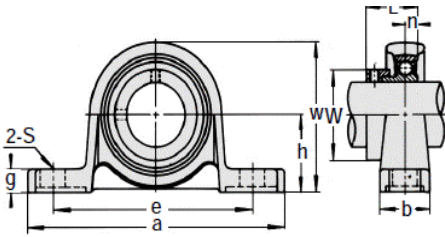

Light Series Oval Flange Bearing Units

Unit No.	Boundary dimensions(mm)				Housing	Bearings Brg No.	Cr(N)	Cor(N)	Mass (Kg)
	Shaft Dia	h	W	a					
UP 000	10	18	35	67	P000	U000+ER	4 600	2 000	0.064
UP 001	12	19	38	71	P001	U001+ER	5 100	2 400	0.090
UP 002	15	22	43	80	P002	U002+ER	5 600	2 800	0.113
UP 003	17	24	47	85	P003	U003+ER	6 000	3 300	0.148
UP 004	20	28	55	100	P04-5	U004+ER	9 350	5 100	0.238
UP 005	25	32	62	112	P05-6	U005+ER	10 100	5 800	0.232
UP 006	30	36	70	132	P06-7	U006+ER	13 200	8 300	0.420
UP 08	8	15	29	55	P08	U08+ER	3 300	1 260	0.350

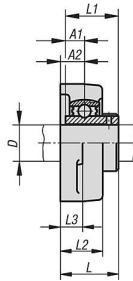
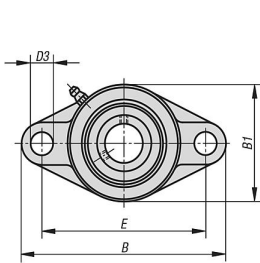

Unit No.	Boundary dimensions(mm)				Housing	Bearings Brg No.	Cr(N)	Cor(N)	Mass (Kg)
	Shaft Dia	B	B1	L					
UFL 000	10	60	36	17.5	FL000	U000+ER	4 600	2 000	0.054
UFL 001	12	63	38	17.5	FL001	U001+ER	5 100	2 400	0.059
UFL 002	15	67	42	18.5	FL002	U002+ER	5 600	2 800	0.068
UFL 003	17	71	46	20.5	FL003	U003+ER	6 000	3 300	0.118
UFL 004	20	90	55	24.5	FL04-5	U004+ER	9 350	5 100	0.160
UFL 005	25	95	60	25.5	FL05-6	U005+ER	10 100	5 800	0.262
UFL 006	30	112	70	26.5	FL06-7	U006+ER	13 200	8 300	0.377
UFL 08	8	48	27	15	FL08	U 08+ER	3 300	1 360	0.030



**ASB<sup>®</sup>**

**Split  
Plumber  
Block  
Housing**

## Split Plummer Block Housing

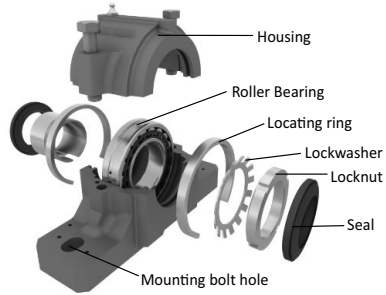
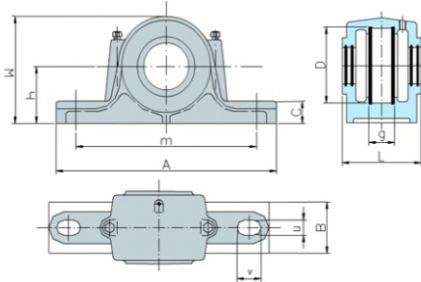

Housing No.	Dimensions(mm)				Bearing No		Adapter sleeves HE (mm) / H (Inch)
	Shaft Dia	D	h	A			
SN 3024	110	180	112	380	-	23024K	3024
SN 3026	115	200	125	410	-	23026K	3026
SN 3028	125	210	140	410	-	23028K	3028
SN 3030	135	225	150	445	-	23030K	3030
SN 3032	140	240	150	450	-	23032K	3032
SN 3034	150	260	160	530	-	23034K	3034
SN 3036	160	280	170	550	-	23036K	3036
SN 3038	170	290	170	550	-	23038K	3038
SN 3122	100	180	112	380	-	23122K	3122
SN 3124	110	200	125	410	-	23124K	3124
SN 3126	115	210	140	410	-	23126K	3126
SN 3128	125	225	150	445	-	23128K	3128
SN 3130	135	250	150	500	-	23130K	3130
SN 3132	140	270	160	530	-	23132K	3132
SN 3134	150	280	170	550	-	23134K	3134
SN 3136	160	300	180	610	-	23136K	3136
SN 3138	170	320	190	650	-	23138K	3138





Housing No.	Dimensions(mm)				Bearing No		Adapter sleeves HE (mm) / H (Inch)
	Shaft Dia	D	h	A			
SN 505	20	52	40	165	1205K	-	205
SN 505	20	52	40	165	2205K	22205K	305
SN 506	25	62	50	185	1206K	-	206
SN 506	25	62	50	185	2206K	22206K	306
SN 507	30	72	50	185	1207K	-	207
SN 507	30	72	50	185	2207K	22207K	307
SN 508	35	80	60	205	1208K	-	208
SN 508	35	80	60	205	2208K	22208K	308
SN 509	40	85	60	205	1209K	-	209
SN 509	40	85	60	205	2209K	22209K	309
SN 510	45	90	60	205	1210K	-	210
SN 510	45	90	60	205	2210K	22210K	310
SN 511	50	100	70	255	1211K	-	211
SN 511	50	100	70	255	2211K	22211K	311
SN 512	55	110	70	255	1212K	-	212
SN 512	55	110	70	255	2212K	22212K	312
SN 513	60	120	80	275	1213K	-	213
SN 513	60	120	80	275	2213K	22213K	313
SN 515	65	130	80	280	1215K	-	215
SN 515	65	130	80	280	2215K	22215K	315
SN 516	70	140	95	315	1216K	-	216
SN 516	70	140	95	315	2216K	22216K	316
SN 517	75	150	95	320	1217K	-	217
SN 517	75	150	95	320	2217K	22217K	317
SN 518	80	160	100	345	1218K	-	218
SN 518	80	160	100	345	2218K	22218K	318
SN 518	80	160	100	345	-	23218K	2318
SN 519	85	170	112	345	1219K	-	219
SN 519	85	170	112	345	2219K	22219K	319

# Split Plummer Block Housing

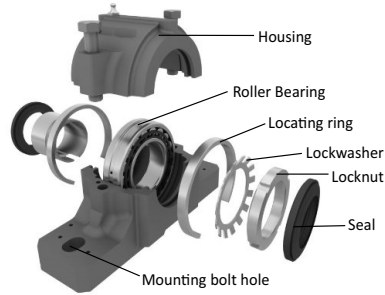
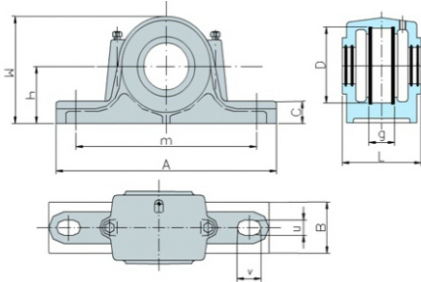

Housing No.	Dimensions(mm)				Bearing No		Adapter sleeves HE (mm) / H (Inch)
	Shaft Dia	D	h	A			
SN 520	90	180	112	380	1220K	-	220
SN 520	90	180	112	380	2220K	22220K	320
SN 520	90	180	112	380	-	23220K	2320
SN 522	100	200	125	410	1222K	-	222
SN 522	100	200	125	410	2222K	22222K	322
SN 522	100	200	125	410	-	23222K	2322
SN 524	110	215	140	410	-	22224K	3124
SN 524	110	215	140	410	-	23224K	2324
SN 526	115	230	150	445	-	22226K	3126
SN 526	115	230	150	445	-	23226K	2326
SN 528	125	250	150	500	-	22228K	3128
SN 528	125	250	150	500	-	23228K	2328
SN 530	135	270	160	530	-	22230K	3130
SN 530	135	270	160	530	-	23230K	2330
SN 532	140	290	170	550	-	22232K	3132
SN 532	140	290	170	550	-	23232K	2332
SN 605	20	62	50	185	1305K	21305K	305
SN 605	20	62	50	185	2305K	-	2305
SN 606	25	72	50	185	1306K	21306K	306
SN 606	25	72	50	185	2306K	-	2306
SN 607	30	80	60	205	1307K	21307K	307
SN 607	30	80	60	205	2307K	-	2307
SN 608	35	90	60	205	1308K	21308K	308
SN 608	35	90	60	205	2308K	22308K	2308
SN 609	40	100	70	255	1309K	21309K	309
SN 609	40	100	70	255	2309K	22309K	2309
SN 610	45	110	70	255	1310K	21310K	310
SN 610	45	110	70	255	2310K	22310K	2310
SN 611	50	120	80	275	1311K	21311K	311
SN 611	50	120	80	275	2311K	22311K	2311
SN 612	55	130	80	280	1312K	21312K	312
SN 612	55	130	80	280	2312K	22312K	2312



Housing No.	Dimensions(mm)				Bearing No		Adapter sleeves HE (mm) / H (Inch)
	Shaft Dia	D	h	A			
SN 613	60	140	95	315	1313K	21313K	313
SN 613	60	140	95	315	2313K	22313K	2313
SN 615	65	160	100	345	1315K	21315K	315
SN 615	65	160	100	345	2315K	22315K	2315
SN 616	70	170	112	345	1316K	21316K	316
SN 616	70	170	112	345	2316K	22316K	2316
SN 617	75	180	112	380	1317K	21317K	317
SN 617	75	180	112	380	2317K	22317K	2317
SN 618	80	190	112	380	1318K	21318K	318
SN 618	80	190	112	380	2318K	22318K	2318
SN 619	85	200	125	410	1319K	21319K	319
SN 619	85	200	125	410	2319K	22319K	2319
SN 620	90	215	140	410	1320K	21320K	320
SN 620	90	215	140	410	2320K	22320K	2320
SN 622	100	240	150	450	1322K	21322K	322
SN 622	100	240	150	450	2322K	22322K	2322
SN 624	110	260	160	530	-	22324K	2324
SN 626	115	280	170	550	-	22326K	2326
SN 628	125	300	180	610	-	22328K	2328
SN 630	135	320	190	650	-	22330K	2330
SN 632	140	340	200	680	-	22332K	2332